

ENGLISH

Before leaving the factory, this appliance was tested and regulated by expert and skilled personnel to give the best operating results. Any repair or regulation that may subsequently be necessary must be carried out with the greatest care and attention. For this reason, we recommend you always contact the Dealer you bought the appliance from or our nearest Service Centre, specifying the type of problem and the model of your appliance. Please remember as well that the original spare parts are available only from our Technical Service Centres. Do not leave the packaging unguarded, both for the safety of children and for the protection of the environment, but dispose of it in a centre for differentiated waste.



The  symbol on the product or on the packaging means that the product must not be considered as normal household refuse, but must be taken to the appropriate collection point for the recycling of electric and electronic equipment. The appropriate disposal of this product helps avoid potential negative consequences on the environment and for health, which could be caused by inappropriate disposal of the product. For more detailed information on the recycling of this product, please contact your municipal offices, the local waste disposal service or the store where the product was purchased.

This appliance complies with the following Directives:

- 2006/95/EC (low voltage equipment)
- 2004/108/EC (electromagnetic compatibility)
- 89/109/EC (articles intended to come into contact with foodstuffs)
- 2002/96/EC (WEEE).
- 2005/32/CE (EuP).

TABLE OF CONTENTS

General warnings	Page	2 - 3
Instructions for use	Page	4 - 12
Instructions for cooking	Page	13 - 15
Cleaning and maintenance	Page	16 - 18
Instructions for installation	Page	19 - 20
Technical characteristic	Page	21

GENERAL WARNINGS

Dear Customer,

Thank you for having chosen our product. This appliance is easy to use; before installing it and using it however, you must read this booklet carefully. You will find all the correct indications for the optimal installation, use and maintenance of the product.

This product is intended for cooking and heating up food. Do not use it for any other purposes.



It is very important to keep this instruction booklet together with the appliance in the case that it is transferred to another person.



This appliance has been designed for non-professional domestic use. It must be used by competent adults and therefore children must be kept away from it and not play with it. During use, the accessible front parts may become very hot. Watch over children and non-self-sufficient people throughout use so that they do not touch the hot parts and are not near the appliance when it is operating.



The product must be installed by competent and trained fitters, who are familiar with the rules and regulations on installation currently in force.

The power supply cable of the appliance must not be replaced by the user. For replacement, contact exclusively qualified personnel.

Never line the oven with sheets of aluminium foil, both not to close the holes and not to alter the regular heat exchange, with consequent damage to the enamel.



IMPORTANT: the accessible parts can become very hot during use. Children should be kept away from the appliance. Take care not to touch the heating elements in the oven.



IMPORTANT: take care with the front part of the oven: hot air and steam may come out of it.

GENERAL WARNINGS

Before using the oven for the first time, any protective film on the oven door must be removed and the oven must be heated, empty, to the maximum temperature for about 45 minutes (elimination of odours and smoke caused by production residue). Then clean the inside of the oven thoroughly with soapy water and rinse well without using an excessive quantity of water that otherwise could penetrate and damage internal components.



Grill racks

Important: for the anti-tilting system to work properly, insert first part "A" holding it facing up as shown in the figure.

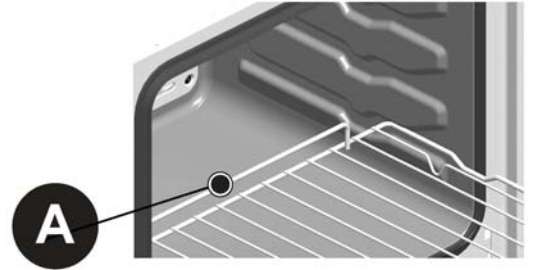

For any repairs, always contact an authorized Technical Service Centre and demand original spare parts. Repairs made by incompetent people may cause damage.

INSTRUCTIONS FOR USE

The knobs of switch A and of thermostat B allow selecting the different functions of the oven and choosing the different cooking temperatures most suitable for the food to be cooked. In some models, the knobs are recessed; before making the selection, you must press to make them appear and then press them again to recess them.

When the oven is functioning, the light stays on.

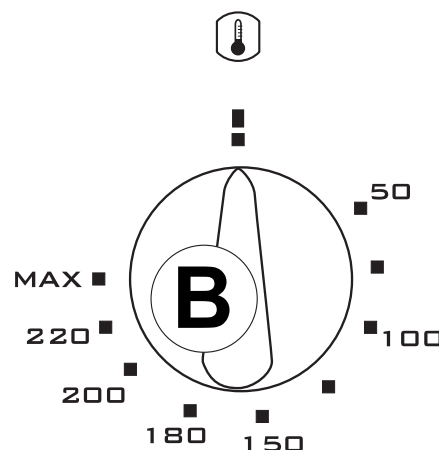
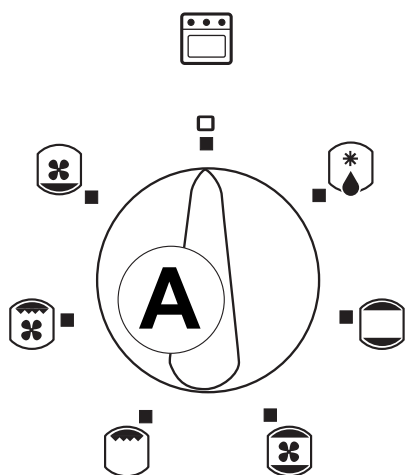

Thawing

 The back fan is on and, by moving the air in the oven, it helps rapidly thaw out frozen food. No heating element is activated.

Traditional cooking

 The upper and lower heating elements are on. The temperature can be adjusted on the whole scale of the thermostat.

Convection cooking

 The upper and lower heating elements and the back fan are on. The temperature can be adjusted on the whole scale of the thermostat.

 The lower heating element and the back fan are on. The temperature can be adjusted on the whole scale of the thermostat.

Grilling

 The grill heating element is on. Adjust the temperature to 200°C on the thermostat.

 The grill heating element and the back fan are on. Adjust the temperature to 200°C on the thermostat.

The oven door must always be closed for all types of cooking.

INSTRUCTIONS FOR USE

DEPENDING ON THE MODEL, THE OVEN COULD HAVE ONE OF THE FOLLOWING COMPONENTS:

Programmable clock

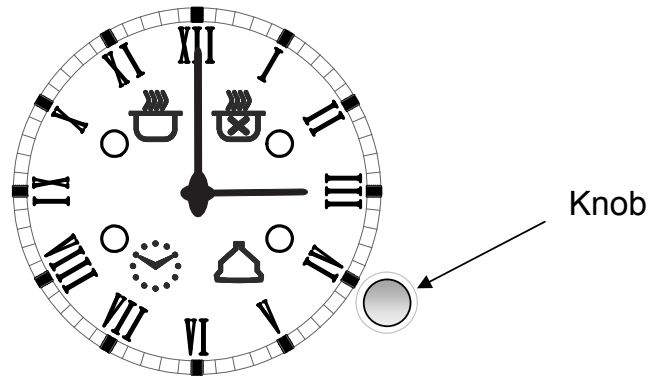



Setting current time

Press the knob until the  light flashes and in 10 seconds set the time rotating the knob. Press again to confirm.

General

- if not deactivated (as per the instructions below), the buzzer stops after 1 minute
- to cancel a setting that has been programmed, keep the knob pressed for about 3 seconds and the lights go out
- the minimum programming time is 2 minutes
- if there is a power cut, all the settings programmed stay memorized and when the power returns, the  light flashes. Press the knob and, when the setting that has been programmed ends, reset the current time.

Timer buzzer (max 180 minutes)

To use as a simple buzzer, press the knob until the  light flashes and set the desired time rotating the knob in less than 10 seconds; the current time will reappear and the  light will stay on. To check the setting memorized, press the knob until the  light flashes.



To deactivate the buzzer, press the knob for about 3 seconds (the  light goes out).

Setting end of cooking time (max 15 hours)

To start cooking immediately and automatically set the cooking time, follow this procedure:

- select the function and temperature desired through the function selector and the thermostat

INSTRUCTIONS FOR USE



- press the knob until the  light flashes, rotate it in less than 10 seconds to select the end of cooking time.
- Confirm by pressing the knob. The current time will reappear and the  light will stay on.



The end of cooking time can be checked by pressing the knob until the  light flashes.

At the end of the cooking time, the buzzer sounds and the oven switches off automatically; to deactivate the buzzer, press the knob, the  light goes out and the oven returns to the manual mode.



Setting the start and end of cooking

To set both the start and the end of the cooking time, follow this procedure:

- select the function and desired temperature with the function selector and the thermostat
- press the knob until the  light flashes and in less than 10 seconds rotate it to select the start of the cooking time desired (maximum 12 hours from the current time)
- press the knob again until the  light flashes and in less than 10 seconds rotate it to select the end of cooking time desired; confirm by pressing the knob.

The current time will reappear and the  and  lights will stay on.

To check the settings memorized, press the knob once.

With the start of cooking, the  light goes off; at the end the buzzer sounds and the oven switches off automatically. To deactivate the buzzer, press the knob, the  light goes off and the oven returns to manual mode.

The maximum programming time, i.e. the total of the hours of delay plus the cooking time, is 15 hours (e.g. setting the delay in 12 hours, the maximum cooking time is 3 hours).

Timer

To use the timer, you have to wind up the buzzer by rotating the knob right round one in a clockwise direction; then, turning back, until the time desired (max. 60 minutes). When the time set has lapsed, the buzzer sounds. This does not switch the oven off.

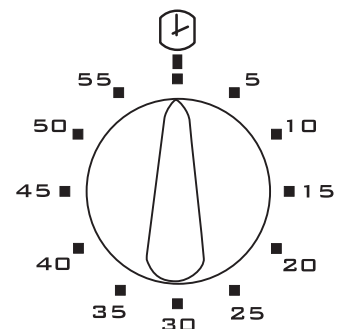

INSTRUCTIONS FOR USE

End of cooking timer

The end of cooking timer, which can be set from 0 to 120 minutes, programmes the end of cooking and switches off the oven. To use it, first you have to turn the knob clockwise by one notch to the  position then, continuing, wind up the buzzer by further rotating the knob for almost one complete turn; lastly, going back, set the desired time.

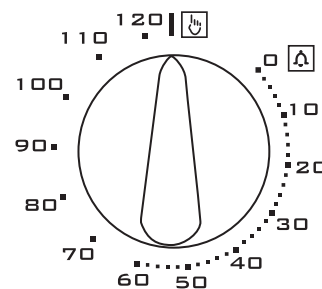

When the time that has been programmed has lapsed, the buzzer sounds and at the same time the oven is automatically switched off. To use the oven with the manual function, excluding the timer, put the knob back to its original position, rotating it in an anticlockwise direction by one notch until the reference of the knob coincides with the  symbol on the control panel.

6 button electronic programmer

Setting the current time

When connected electrically, the display flashes showing 0.00. Press buttons (1) and (2) at the same time and set the current time, pressing the (-) and (+) buttons within 4 seconds; the oven will continue to function manually and can be used without any programming.

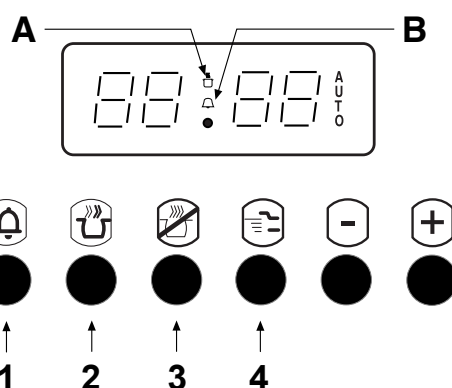

General notes

- between 10.00 p.m. and 6.00 a.m. the brightness of the display is automatically reduced.
- if it is not deactivated (as per the instructions below), the buzzer stops after 2 minutes.
- any programming described below is activated about 4 seconds after setting.
- the maximum time of programming is 23 hours 59 minutes.
- if there is a power cut, all the settings programmed are cancelled; when power returns, the display flashes showing 0.00. To restore the functioning of the appliance, reset the current time and any programme.

Timer buzzer

To use it as a simple buzzer, press button (1) and programme the time desired, pressing the (-) and (+) buttons within 4 seconds; the current time will reappear and the symbol (B) will be activated. To deactivate the buzzer, press any of the buttons from (1) to (4); the symbol (B) is deactivated.

INSTRUCTIONS FOR USE

Programming end of cooking

To start cooking immediately and automatically set the duration, proceed as follows:

- select the function and the temperature desired using the function selector and the thermostat
- press button (2) and set the cooking time, pressing the (-) and (+) buttons within 4 seconds.

The current time will reappear and the (A) and (AUTO) lights will stay on. The remaining cooking time can be checked by pressing button (2), or changed by repeating the same procedure.

For any cancellation of the programming set, reset the cooking time to 0.00 and, after the current time has reappeared, press button (4) to restore the manual function. When cooking is finished, the buzzer sounds and the oven is switched off automatically.

To deactivate the buzzer, press any of the buttons from (1) to (4). To return the programmer to the manual function, press button (4).

Setting the start and end of cooking

To programme both the start and the end of cooking, proceed as follows:

- select the function and the temperature desired using the function selector and the thermostat
- press button (2) and set the cooking time, pressing the buttons (-) and (+) within 4 seconds
- press button (3) and set the time when you want the cooking to end in the same way.

The current time will reappear and light (AUTO) and, when cooking starts, light (A), will stay on. To cancel the programming set, put the cooking time back to 0.00 and, after the current time has reappeared, press button (4) to restore the manual function. When the cooking ends, the buzzer sounds and the oven is automatically switched off. To deactivate the buzzer, press any of the buttons from (1) to (4). To restore the programmer to the manual function, press button (4).

Children's safety lock

The programmer has a safety lock which prevents programming cooking and therefore the oven from functioning.

Activating the lock:

- press buttons (1) and (2) at the same time for about 8 seconds
- the display shows "ON"; release the buttons
- press the (+) button; the display shows "OF" and the "...key..." symbol.

At this point, the safety lock is activated and after about 5 seconds the display shows the current time and the "...key..." symbol.

Deactivating the lock:

- press buttons (1) and (2) simultaneously for about 8 seconds
- the display shows "OF"; release the buttons

INSTRUCTIONS FOR USE

- press the (+) button; the display shows “ON”

At this point the safety lock is deactivated and after about 5 seconds the display shows the current time.

2 button electronic end of cooking

Setting the current time

When the electricity has been connected, the display flashes, showing 0.00. Press both buttons at the same time and set the current time, pressing the (-) and (+) buttons within 4 seconds; the oven will continue to function manually and can be used without any programming.

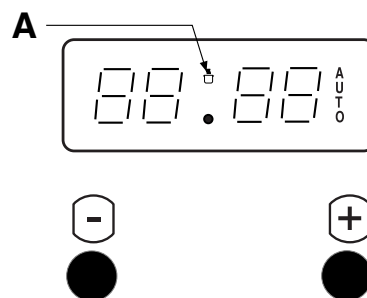

General notes

- If not deactivated (as per instructions below) the buzzer stops after 2 minutes.
- Any programming described below is activated about 4 seconds after setting.
- The maximum programming time is 23 hours and 59 minutes.
- If there is a power cut, all the programmed settings are cancelled; when power returns, the display flashes, showing 0.00. To restore the functioning of the appliance, reset the current time and any programme.

Setting end of cooking

To start cooking immediately and automatically set the cooking time, proceed as follows:

- Select the function and temperature desired through the function selector and the thermostat.
- Set the cooking time, pressing the (-) and (+) buttons.
- The display will show the cooking time set and the symbol (A).

To cancel the programming set, put the cooking time back to 0.00 and, after the current time has reappeared, press any of the buttons to restore the manual function and the symbol (A) is switched off.

When the cooking is finished, the buzzer sounds and the oven is switched off automatically, the current time appears and the symbol (A) flashes. To deactivate the buzzer and bring the oven back to manual functioning, press any one of the buttons and the symbol (A) disappears.

Children's safety lock

The programmer has a safety lock that prevents programming cooking and therefore the functioning of the oven.

Activating the lock:

- press the (-) and (+) buttons at the same time for about 8 seconds
- the display shows “ON”; release the buttons

INSTRUCTIONS FOR USE

- press the (+) button; the display shows “OF” and the “...key...” symbol.

At this point the safety lock is activated and after about 5 seconds the display shows the current time and the “...key...” symbol.

Deactivating the lock:

- press the (-) and (+) buttons at the same time for about 8 seconds
- the display shows “OF”; release the buttons
- press the (+) button; the display shows “ON”

At this point the safety lock is deactivated and after about 5 seconds the display shows the current time.

Electronic touch programmer

Setting the current time

When the power is connected, “12:00” and the symbol  flash on the display. By touching any one of the controls (+, - or **SELECT**), the symbol **MAN** appears and it is possible to set the time, pressing the - or + buttons within 5 seconds.

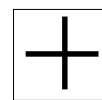
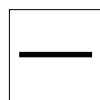
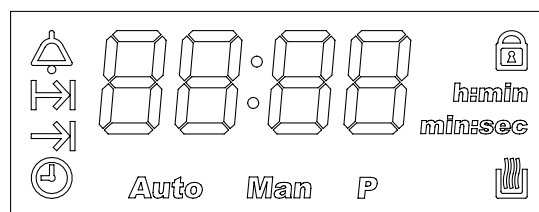

Subsequent adjustments of the time can be made by repeatedly touching the **SELECT** control until the  symbol flashes and adjusting the time as described above.



General notes

- Setting the current time whilst an automatic programme is active will cancel the programme.
- The loudness of the buzzer can be modified by repeatedly touching the **SELECT** control until the level set appears (**L1**, **L2** or **L3**) and pressing + or -.
- If not deactivated, the buzzer stops automatically after about 7 minutes.
- The maximum programming time is 23 hours 59 minutes.
- If there is a power cut, all the programmed settings are cancelled; when power returns, the display flashes, showing 12:00. To restore the functioning of the appliance, reset the current time and any programme.

Timer buzzer

To use it as a simple timer, touch the **SELECT** control repeatedly until the  symbol flashes, set the time desired, pressing + or -, after about 5 seconds the  symbol stops flashing and the time starts to decrease; to modify the time set or zero it, press + or -.

When the time is finished, touch any one of the controls to deactivate the buzzer. The maximum time that can be set is 99 minutes.

INSTRUCTIONS FOR USE

Setting the end of cooking

To start cooking immediately and set cooking time, proceed as follows:

- put the dishes to be cooked in the oven and select the function and temperature desired using the functions selector and the thermostat
- touch the **SELECT** symbol repeatedly until the flashing  symbol appears and set the cooking time within 5 seconds, pressing + or -.



After a few seconds, the current time will reappear and the  and **AUTO** symbols will stay on.

The remaining cooking time can be checked by pressing the **SELECT** symbol until the  symbol is selected, or modified or zeroed by pressing + or -.

When the cooking is finished, the buzzer sounds and the oven is switched off automatically, the display shows 0.00 and **MAN** flashes. To deactivate the buzzer, press any of the controls; touch **SELECT** to put the programmer back to manual, the **MAN** symbol stops flashing and the oven can be used again.

Setting the start and the end of cooking

To programme both the starting time and the end of cooking, proceed as follows:

- touch the **SELECT** control until the  symbol appears, set the cooking time pressing + or - within 5 seconds;
- touch the **SELECT** control again until the  symbol is selected to set the end of the cooking.
- put the dishes to be cooked into the oven and select the function and the temperature desired through the function selector and the thermostat.

The cooking will start from the end of cooking time minus the cooking time. 5 seconds after the release of the controls the current time will reappear and the **AUTO** will stay active as will the  symbol at the start of cooking.

When the cooking is finished, the buzzer sounds and the oven is switched off automatically. To deactivate the buzzer, press any one of the controls; touch **SELECT** to bring the programmer back to manual. The **MAN** symbol stops flashing and the oven can be used again.

To cancel the programme, zero the cooking time.

Safety lock

This electronic programmer has a function that locks the oven or the programmings set.

The lock does not work when the timer is active.

Activation: touch the + control for about 5 seconds then the  symbol will appear.

Notes:

- if the lock is activated with the display showing the current time and no programming set (end of cooking or start and end of cooking), the oven is locked
- if it is activated with the oven functioning or a programming selected (end of cooking or start and end of cooking), the lock prevents modifying the programmings.

Deactivation: touch the + control for about 5 seconds.

INSTRUCTIONS FOR USE

NOTE : in the case of a power cut, when the power returns, the lock will still be active.

Thermostat light

This goes on every time the thermostat acts to stabilize the cooking temperature in the oven and it goes off when the oven reaches the pre-set temperature.

Safety thermostat

This interrupts the power supply to avoid excessive overheating due to incorrect use of the appliance or a possible defect of the components. If this device comes into action due to incorrect use, you only have to wait for the oven to cool down before you can use it again. However, if it is due to a defect of the components, you must contact the Technical Assistance Service.

Cooling motor

Some ovens have a motor to cool the internal components. This device goes on automatically however the oven is used.

INSTRUCTIONS FOR COOKING

ROASTING

For perfect roasting, the oven has to be pre-heated to the pre-set cooking temperature. Only very fatty meat can be cooked with the oven starting from cold. Never use shallow pans or the drip-tray as pans for roasts, to dirty the walls of the oven as little as possible, avoid the fat splattering, the juices burning quickly and smoke being produced.

Use deep pans, preferably made from terracotta, placed on the shelf about half-way up the oven.

The table shows you some examples of thermostat settings and cooking times. The cooking times can vary depending on the nature of the foods, its evenness and volume. We are certain that your experience will soon suggest possible variations to the values shown in the cooking times table.

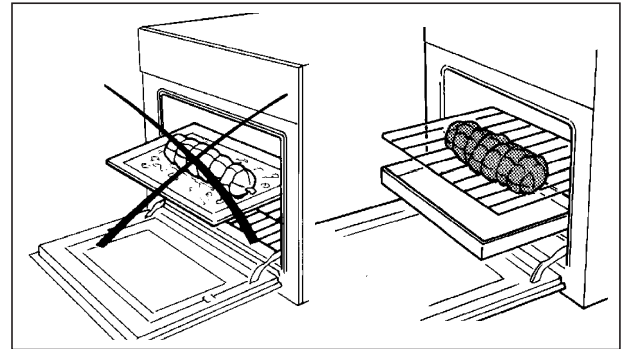

Some practical advice to save energy

The oven can be switched off a few minutes before the end of cooking; the remaining temperature will be sufficient to finish cooking. Open the door of the oven as infrequently as possible; to check the degree of cooking, look through the window (the oven light is always on).

General advice

The oven offers various types of heating

- traditional heating for roasting
- ventilated heating for baking cakes, biscuits etc.

If you choose ventilated heating, the best possible use should be made of its advantage: to cook roasts and bake cakes on different shelves or to prepare complete menus saving time and energy.

Ventilated heating

This function creates a continuous circulation of hot air that allows simultaneous cooking on two shelves. The temperatures are below traditional ones.

Traditional heating

This is particularly suitable for roasting game and baking bread and sponge cakes. It is a good rule to put the food to be cooked in the oven when it has reached the cooking temperature, i.e. when the thermostat light goes off.

GRILLING

For grilling, the oven should be pre-heated for about 5 minutes. When grilling, the heat comes from above and is based on the irradiation of infrared rays. It is suitable for meat which is not very thick and toast. Meat and fish to be grilled should be lightly brushed with oil and always placed on the shelf, which then slides into the position nearer or further from the grilling element, in proportion to the

INSTRUCTIONS FOR COOKING

thickness of the meat; the table shown below gives some examples of cooking times and the position of the food. The cooking times can vary according to the nature of the food, its evenness and volume.

BAKING

The circulation of air in the oven ensures instantaneous and even distribution of the heat. Pre-heating the oven is no longer necessary.

However, for more delicate baked goods, the oven can be pre-heated.

Several trays for baking can be placed in the oven, taking care not to use the first shelf starting from the top. Other kinds of food (fish, meat etc.) can also be cooked at the same time, without there being any transmission of flavour and smells.

This multiple cooking is possible because, although having different cooking times, the cooking temperature of the different foods is the same.

COOKING AU GRATIN

This term refers to the change of the surface of food which is generally pre-cooked and when placed in the oven, it becomes crisp and golden in appearance.

“Gnocchi alla romana”, “polenta pasticciata”, rice, lasagne, pasta and vegetables in béchamel sauce are the typical dishes for this type of cooking.

THAWING

Thawing takes place as at room temperature with the advantage of being quicker. The ten hours needed in the fridge are reduced to one hour for every kilo of meat. Place the meat in its packaging on a plate. Put it into the oven.

COOKING TIMES

The table shows some examples of the thermostat setting and cooking time. The cooking times can vary depending on the nature of the food, its evenness and its volume. We are sure that your experience will soon suggest possible variations to the values shown in the table.

Notes:

- For roasts of beef, veal, pork and turkey with bones or rolled roasts, increase the times in the table by about 20 minutes.
- The indication in the table for the use of the shelves is the best one in the case of cooking on several levels.
- The times described in the table refer to the cooking of one food only; for more dishes, the cooking times have to be increased by 5-10 minutes.

INSTRUCTIONS FOR COOKING

Table of oven cooking times

Kind of food	Shelf no.	Oven temperature °C	Time in minutes
			
FOOD			
<i>Long cooking roast</i>	2	220-MAX	dep. on qty.
<i>Short cooking roast</i>	2	225-MAX	50-60
<i>Poultry (guinea-fowl, duck etc.)</i>	1	210-MAX	150-180
<i>Chicken</i>	2	225-MAX	50-60
<i>Game</i>	1	200-225	dep. on qty.
<i>Fish</i>	1	180-200	20-25
BAKING			
<i>Christmas cake</i>	1	160-200	60-70
<i>Plum-cake</i>	1	170-180	90-100
<i>Orange cake</i>	1	170-180	80-100
<i>Savoy biscuits</i>	2	200	40-45
<i>Croissants</i>	2	215-230	35-40
<i>Puff pastry</i>	2	215	30-40
<i>Sponge cake</i>	2	200-215	30-35
<i>Meringues</i>	1	140	60-80
<i>Chou pastry</i>	2	215-230	30
<i>Fruit tarts (shortcrust pastry)</i>	2	MAX	30-35
<i>Fruit tarts (yeast pastry)</i>	2	230	20-30

Table of grilling times

Nature of food	Quantity Kg	Shelf no.	Oven temperature °C	Pre-heating in minutes	Time in minutes
					
<i>Veal chops</i>	1	3-4	200	5	8-10
<i>Lamb chops</i>	"	"	"	"	12-15
<i>Liver</i>	"	"	"	"	10-12
<i>Mince rolls</i>	"	"	"	"	12-15
<i>Calf's heart</i>	"	"	"	"	12-15
<i>Trussed roast</i>	"	"	"	"	20-25
<i>Half-chicken</i>	-	"	"	"	20-25
<i>Fish fillet</i>	-	"	"	"	12-15
<i>Stuffed tomatoes</i>	-	"	"	"	10-12

CLEANING AND MAINTENANCE

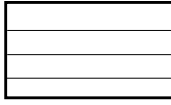
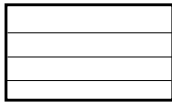

Important: before carrying out maintenance or cleaning the oven, unplug it and wait for it to cool down.

General cleaning

To keep the enamelled part shiny for as long as possible, the oven must be cleaned each time after using it. Leave the oven to cool down and you can easily remove the deposits of fat with a sponge or damp cloth and warm soapy water and, if necessary with a product on the market. Do not use abrasive cloths or sponges that could irreparably damage the enamel. The control panel, handle and knob of white ovens must also be cleaned each time in order to avoid greasy steam turning them yellow in time. After use, rinse the stainless steel parts well with water and then dry them with a soft cloth or chamois leather. For stubborn stains, use normal non-abrasive detergents or specific products for stainless steel or a little warm vinegar. Clean the window of the oven door only with hot water, avoiding the use of rough cloths.

Oven with copper surfaces: the copper surfaces have a special protection. To keep the surfaces intact, we recommend using, when the oven is cold, a soft clean cloth and a neutral detergent for delicate surfaces. Never use abrasive tools.

Do not clean with a jet of steam.

Ovens with a tilting upper resistance for cleaning

- 1 Important: make sure that all the controls are in the off position and wait for the resistance to cool down
- 2 Hold the front part of the grill resistance whilst you unscrew the knurled nut of the fixing screws
- 3 Gently lower the front part of the resistance until it stops.
- 4 During cleaning, avoid applying excessive strain on the resistance.
- 5 After cleaning, carefully remove all residue to detergents and water from the resistance.
- 6 Lift up the front part of the resistance and tighten the knurled nut of the fixing screws.

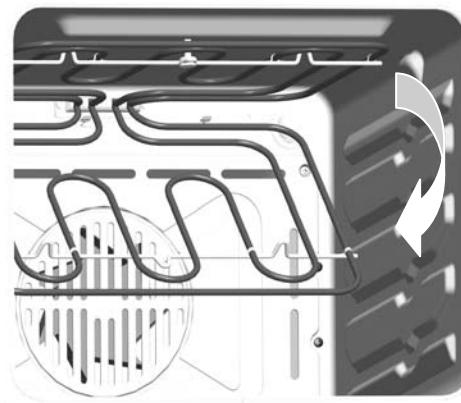

Do not use the oven with the resistance lowered.

CLEANING AND MAINTENANCE

Cleaning the oven door

Dismounting the door

1. Open the oven door to its full extent
2. Move the hinge stops depending on the model, as shown in figure A1 or A2.
3. Turn the door towards the closed position until it rests on the stops. This blocks the hinge spring. Continue to close the door so as to remove the hinges from their housings, then raise and lift off the door (fig. B).

Perform the operations described above in reverse order to fit the door back in place.

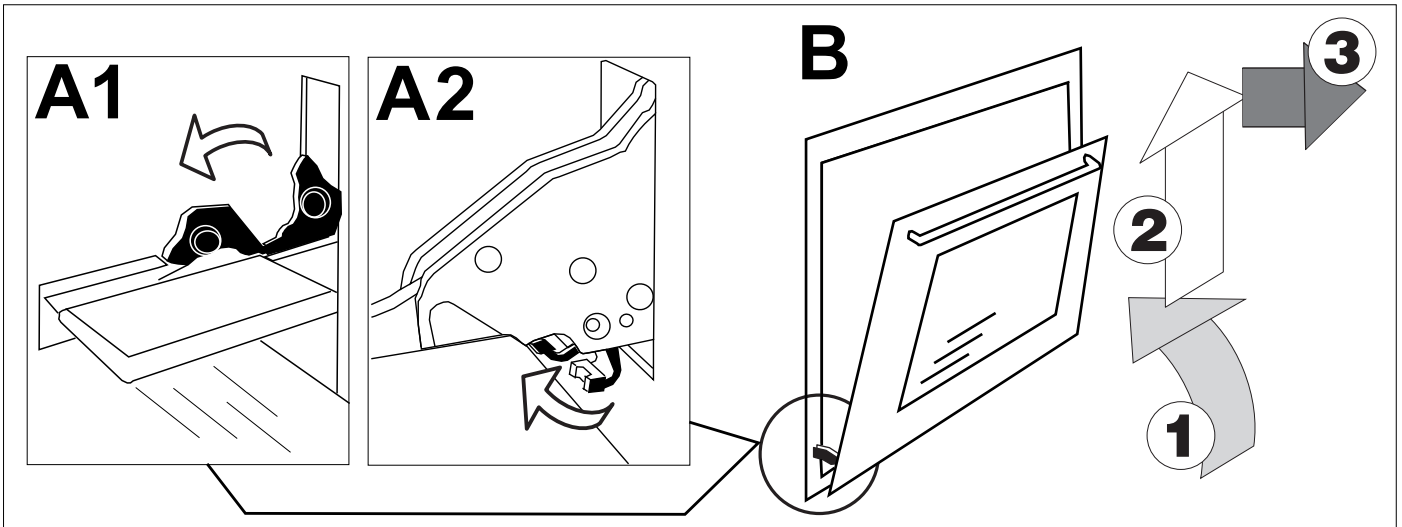

Dismounting the glass panes of the door



IMPORTANT: for your safety, before dismounting the glass panes, remove the door from the oven.

For easier cleaning, after having removed the door from the oven, the glass panes can be dismounted. You only have to remove the two upper blocks (fig. C) to be able to slide out the windows (fig. D). After cleaning, remount the glass panes by replacing the blocks and checking that all the parts are correctly fixed. Only then remount the door on the oven.

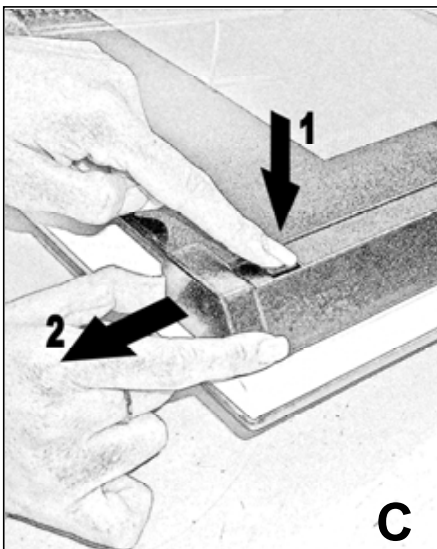

Please keep the (OK) symbol below on the right.

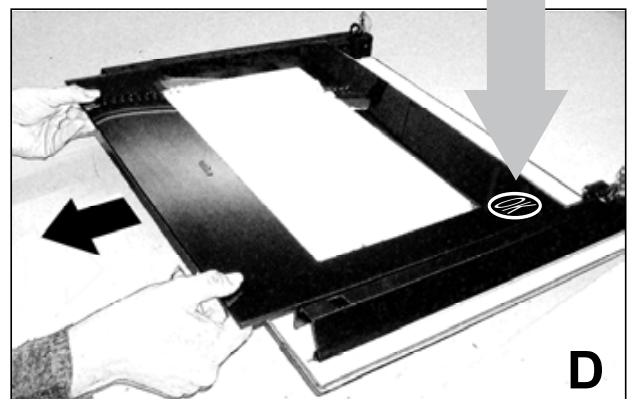

CLEANING AND MAINTENANCE

All the glass used in this appliance has undergone a special safety treatment. In the case of breakage, the glass shatters into small square and smooth pieces which are not dangerous because they are not sharp.

Please take care and avoid thermal shocks for the glass pane, for example, never start cleaning when it is hot.

Replacing the oven light

After having disconnected the oven from the power supply, unscrew the glass protection cap and then the bulb and replace it with another one suitable for high temperatures (300°C / E14). Remount the glass cap and reconnect the oven.

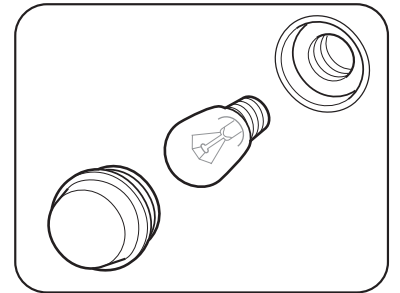

Self-cleaning catalytic panels (optional)

Some models of the oven can have self-cleaning panels, covering the walls, mounted in the muffle. If they are not already supplied, you can contact your dealer or Service Centre to purchase them.

These special panels, to be fixed to the side walls and the rear wall, are covered with a special micro-porous catalytic enamel that gradually oxidises and vaporises splattered oil and fat, eliminating them during cooking at over 200° C. If after cooking very greasy or fatty food, the oven is not clean, switch it on empty at the maximum temperature for the time necessary (max. 1 hour) for it to become clean again. The self-cleaning panels must not be washed or cleaned with abrasive products or products containing acids or alkalis, but only regularly wiped with a cloth soaked in water.

INSTRUCTIONS FOR INSTALLATION

Electrical connection



Disconnect the power supply before every operation

The appliances have a three-pole power supply cable and are ready to work with alternating current, at the voltage shown on the “ratings plate” at the end of the booklet and on the product. The earth conductor of the cable is yellow/green.

Connecting the power supply cable to the mains

Connect a plug suitable for the load shown on the ratings plate of the product to the oven power supply cable. In the case of direct connection to the mains (cable without a plug), an omnipolar switch with an appropriate load must be inserted upstream of the appliance, with a minimum opening of contacts of 3 mm. (the earth connecting cable must not be interrupted by the switch).

Before proceeding with the connection to the mains, make sure that:

- the electricity meter, the protection valve, the power line and the socket are sufficient to support the maximum load required (see ratings plate)
- the electricity system is earthed, compliant with current regulations
- the socket or omnipolar switch can easily be reached after the oven has been installed
- after making the electrical connection, check that the power supply cable does not come into contact with parts subject to heating up
- do not use adaptors or shunts as they can heat up or burn.

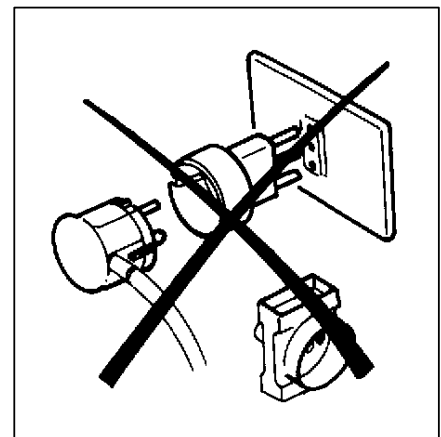

In the cases in which a hob is also installed, the hob and the oven must be connected separately, both for electrical safety reasons and to make extracting the oven easier.

After connection, put the power back on only after the oven has been put into the unit.

The manufacturer is not responsible for direct or indirect damage caused by incorrect installation or connection. All the operations relative to installation and electrical connection must therefore be carried out by trained personnel working according to local and general regulations in force.

INSTRUCTIONS FOR INSTALLATION

Recessing and fixing to unit:

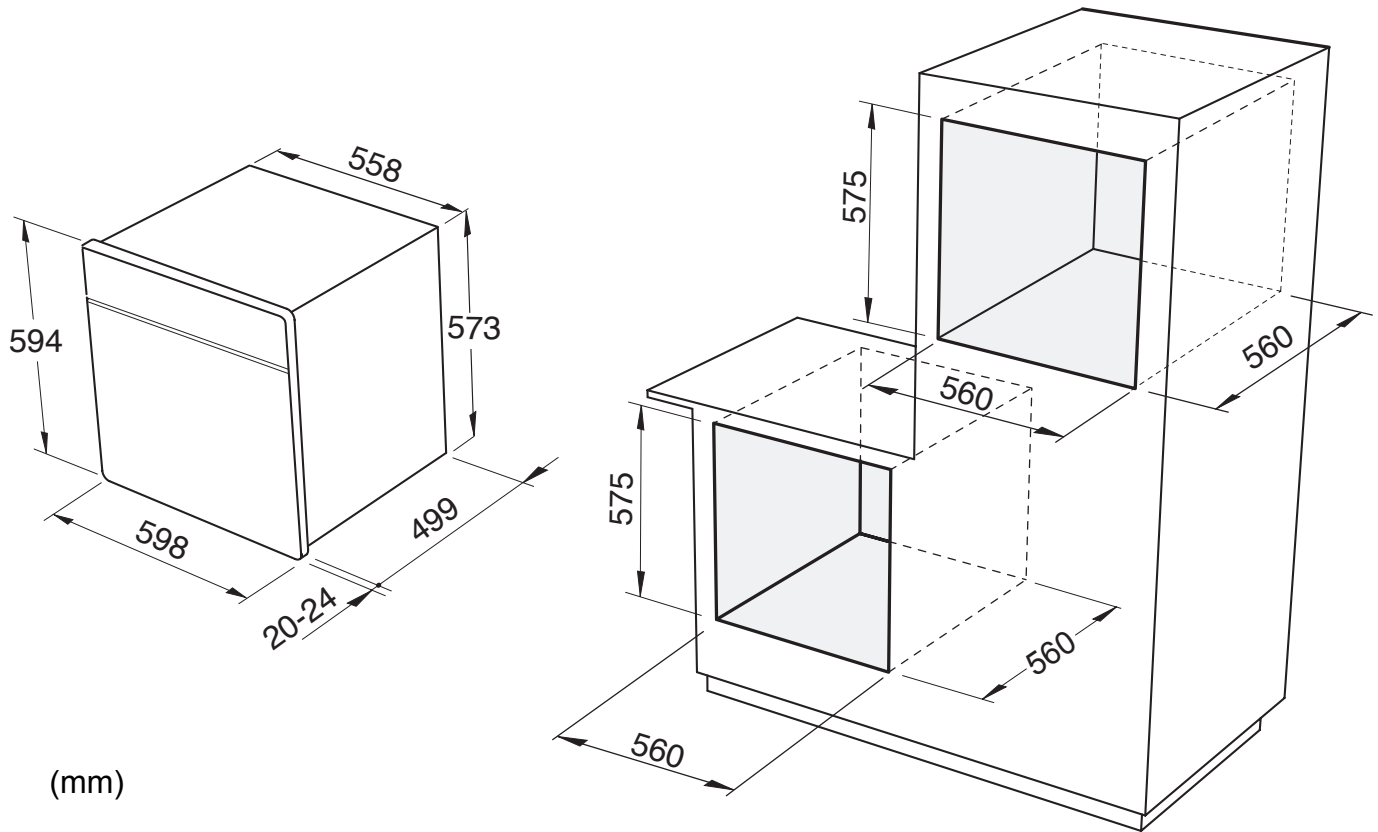

(mm)

Put the oven into the recess laying it on the base and pushing it until the lateral jambs touch the sides of the unit.

Open the door and fix the oven with four wood screws which must be screwed through the holes in the lateral jambs of the oven.

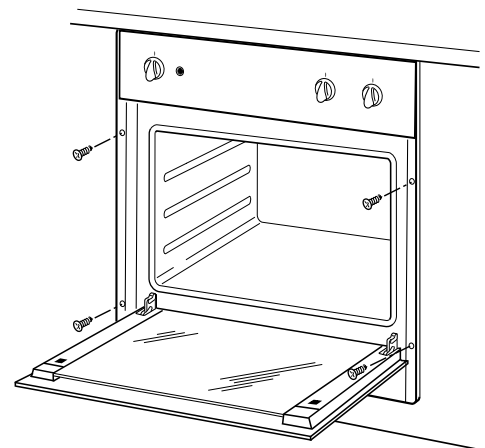

Ensure that the oven is fixed in a perfectly stable fashion, as shown, and that the electrical parts are isolated so that they do not come into contact with the metal parts. In addition, the adhesive that bonds the laminate to the unit must be resistant to temperatures of not below 90°C to avoid deformation and ungluing of the surface.

TECHNICAL CHARACTERISTIC

Power of possible heating elements:



(Upper+Grill) 800+1800W



(Lower) 1000W

Light bulb:



25W (max)

Working capacity of the oven:

58lt

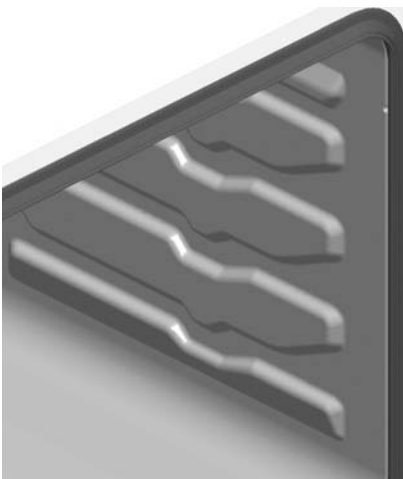

56lt



53lt



Etichetta dati caratteristici del prodotto
Label of ratings plate
Etiquette des spécifications du produit
Etiqueta datos característicos del producto
Табличка характеристик оборудования

