



Your Style...Your Life

## Multifunctional ovens

FFB 4ST S

FFB 5M S

FFA 5M1 S

FFA 9M1 XS

FFA 9M5 XS

FFA 5E1 XS

FFA 5E5 XS

FFA 9E1 XS

FFA 9E2 XS

FFA 9E3 XS

FFA 9E5 XS

FFA PB9E5 XS

FFA PB 6004 XW/BL

## **Table of contents**

<b>Technical specifications</b>	<b>3</b>
<b>Installation instruction</b>	<b>3-5</b>
<b>Control panel</b>	<b>6</b>
<b>Description of cooking functions</b>	<b>7-8</b>
<b>Cooking table</b>	<b>9</b>
<b>Using the grill</b>	<b>10</b>
<b>Using the rotisserie</b>	<b>10</b>
<b>Minute minder</b>	<b>11</b>
<b>End of cooking 120'</b>	<b>11</b>
<b>Analog programmer</b>	<b>12</b>
<b>Analog timer</b>	<b>12</b>
<b>Electronic programmer</b>	<b>13-19</b>
<b>Replacing the oven light</b>	<b>20</b>
<b>Removing the oven door</b>	<b>20</b>
<b>Optional</b>	<b>21</b>
<b>Cleaning and maintenance</b>	<b>22</b>

## INSTALLATION INSTRUCTION

**Thank you for choosing one of our products. It will offer you many years of excellent performance. Please carefully read the instructions and suggestions contained in this manual for correct use of our products.**

### Technical details

This appliance conforms to the standard regarding suppression of radio reception interference.

### Voltage regulations

230 V a.c. - 50 Hz / 220 V a.c. - 60 Hz

### Muffle dimensions:

Height : 340 mm  
Length : 440 mm  
Depth : 390 mm  
Volume : 59 lt

### Voltage of heating elements

Static oven 1:

- Lower heating element : 1,3 kW
- Top heating element : 0,9 kW
- Maximum input of heating element : 2,65 kW

Static oven 2:

- Lower heating element : 1,3 kW
- Top heating element : 0,9 kW
- Grill element : 1,35 kW
- Maximum input of heating element : 2,25 kW

Fan oven :

- Fan heating element : 2,3 kW
- Grill heating element : 1,35 kW
- Maximum input of heating element : 2,38 kW

Fan-Multifunction oven:

- Lower heating element : 1,3 kW
- Top heating element : 0,9 kW
- Grill element : 1,35 kW
- Maximum input of heating element : 2,28 kW

Multifunction oven :

- Lower heating element : 1,3 kW
- Top heating element : 0,9 kW
- Fan heating element : 2,3 kW
- Grill element : 1,35 kW
- Maximum input of heating element : 2,38 kW

### Built-in installation

**IMPORTANT:** The unit must be correctly installed in accordance with Manufacturers instructions and by qualified person.

Maintenance and service must be carried out after the power supply has been disconnected.

**ELECTRICAL CONNECTION:** Make sure that the voltage supply is the same as what is on the rating plate which can be found on the lower part of the front of the oven.

The oven must be connected at the back using a cable with minimum section of 1.5 mm, providing an omnipole switch in compliance with current regulations with a contact opening distance of at least 3 mm.

### Warning: this appliance must be earthed.

Our company declines any liability for failures in the earth connection of for earth connection that is not in compliance with the regulation in force.

### Oven preparation and pre-use

Before using the oven, thoroughly clean the inside with non-abrasive soap and lukewarm water. Fit the rack and drip pan in their runners. Once you have completed the operation, bring the oven to maximum temperature for approximately 20 minutes in order to eliminate any remains of manufacturing grease, oil or resins that can produce unpleasant smells during cooking and ventilate the room.

Once you have done this operation, the oven is ready for the first cooking.

**IMPORTANT:** Each time you want to clean the oven, make sure the warning light is off and the oven is disconnected.

**Important notices for the installation:**

The oven can be built into a standard 600 mm housing Unit as shown in fig. 1 when built-under the work top, or in a tall housing unit when built-in a column.

This appliance must be installed by a competent person and with particular attention to ventilation.

In both cases ventilation provisions must be made.

**CAUTION: ALWAYS KEEP CHILDREN OFF THE OVEN WHEN HOT.**

This being a gap at the back of the housing unit between 85 and 90 mm as indicate in fig. 1. The fixing of the oven in the cabinet is made by 4 screws "A" that are on the corner of the oven door-frame.

When placing the oven in the housing unit, do not use the oven door as a lever for lifting the oven.

Do not put excess pressure on the open door once opened.

**Slot-in unit for fan and multifunction oven**

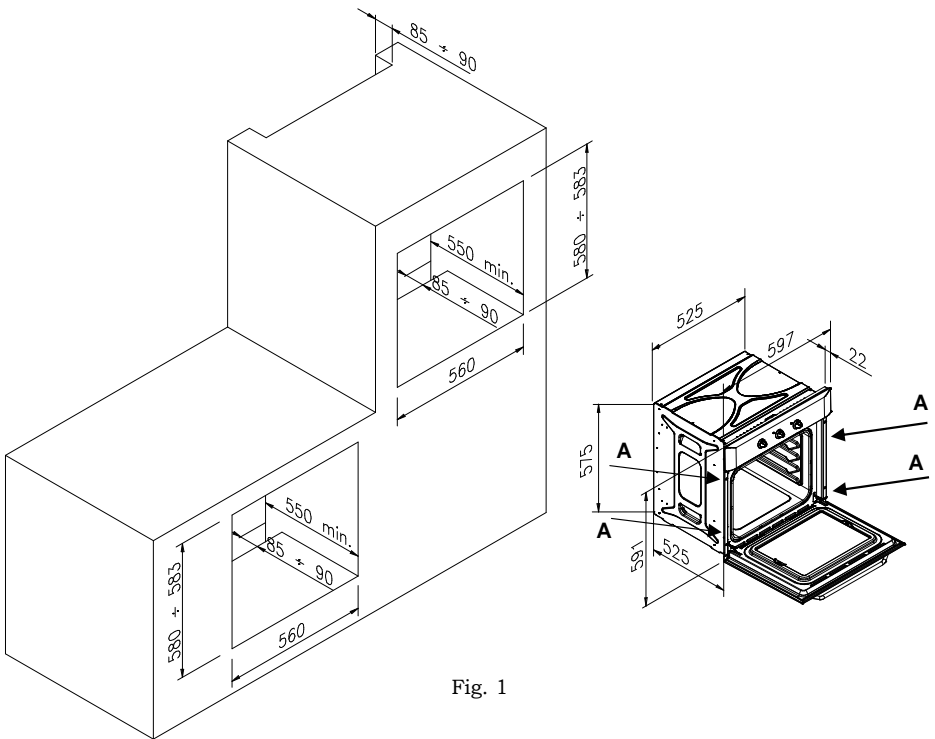

Fig. 1

**Slot-in unit for static oven**

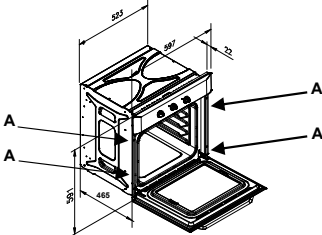
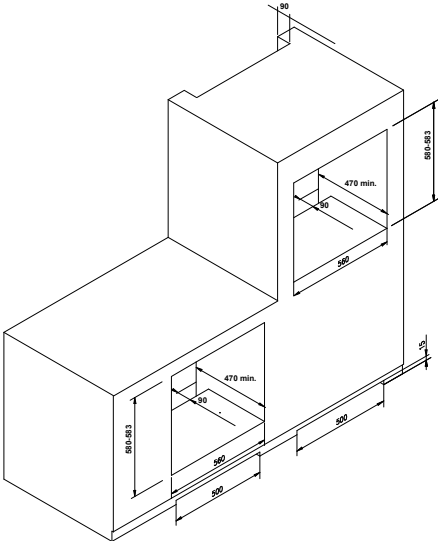
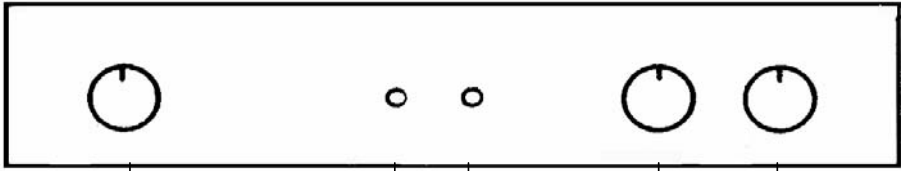

Fig. 1a

# Control panel



7

5

6

2

1

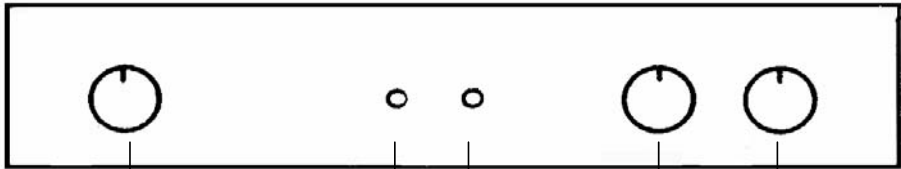

4

5

6

2

1

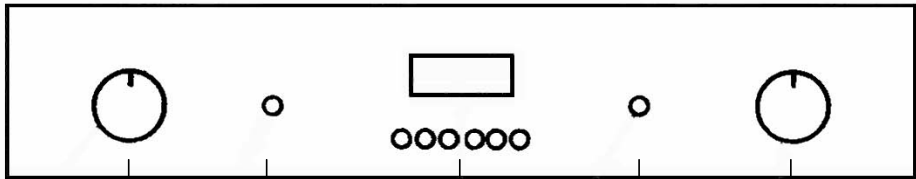

1

6

3

5

2

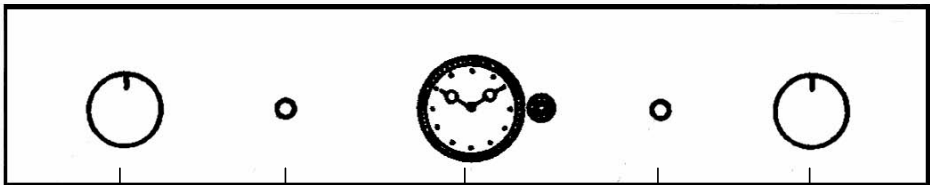

1

6

8

5

2

- 1. Thermostat
- 2. Selector
- 3. Electronic timer
- 4. End of cooking

- 5. Green light
- 6. Yellow light
- 7. Minute minder
- 8. Analog programmer and Analog timer

## Selector functions:



### **DEFROSTING**

The oven and the green light will stay on during this and all the following functions.

The fan motor comes on, but there is no heat. The oven door should be kept in the close position. Recommended use: for defrosting frozen foods in general, this will help cut down the defrosting time by about on third of the normal time.



### **TRADITIONAL OVEN COOKING**

By turning the thermostat knob, a desired temperature of 50°C to 250°C can be selected. The yellow light will go off when the oven has reached the desired temperature. It is recommended that the oven is pre-heated before introducing the food.



### **MULTIFUNCTION**

The fan and the circular element come on. The heat is diffused by the fan to give an even temperature in the oven by adjusting the thermostat, a desired temperature of 50°C to 250°C can be obtained.

It is not necessary to pre-heat the oven before introducing the food.



### **CENTRAL GRILL ELEMENT**

By turning the thermostat knob, a desired temperature of 50°C to 250°C can be selected, keeping the door closed.

Recommended use: for grilling smaller items of food.



### **DOUBLE GRILL ELEMENT**

By turning the thermostat knob, a desired temperature of 50°C to 250°C can be selected, keeping the door half-open or closed. In the latter case the use of the grill deflector is not necessary.

Recommended use: for grilling larger area of food.



### **SEMI FORCED AIR CONVECTION**

The thermostat has to be set at the desired temperature between 50°C and 250°C. The fan and the grill element allow a fast and deep cooking for particular food. It is recommended that the oven be pre-heated for a few minutes.



### **SEMI FORCED AIR CONVECTION WITH LOWER ELEMENT**

The thermostat has to be set to the desired temperature. It is not recommended that you have to pre-heat the oven.

Recommended use: for warming or very slow cooking of food.

## Selector functions:



### **TRADITIONAL COOKING + FAN**

By turning the thermostat knob, a desired temperature of 50°C to 250°C can be selected, keeping the door closed. This cooking mode integrates natural convection and ventilation.

Cooking mode suited to bake bread, pizzas and lasagne.

It is recommended that the oven be pre-heated



### **LIGHT ONLY**



### **BOTTOM ELEMENT ONLY**

Select the desired temperature between 50°C and 250°C.

Suitable for very slow cooking and warming up of food.



### **TOP HEATING ELEMENT**

Select the thermostat temperature from 50°C to 250°C.

For keeping cooked food warm or gently reheating.



### **GRILL + TURNSPIT**

By turning the thermostat knob, a desired temperature of 50°C to 250°C can be selected, keeping the door closed.

When the grill is in use the turnspit automatically is on.



### **SEMI FORCED AIR CONVECTION WITH LOWER HEATING ELEMENT**

The fan will come on with the lower heating element.

The thermostat has to be set to the desired temperature. It is not recommended that you have to pre-heat the oven.

Recommended use: for warming or very slow cooking of food.



### **PIZZA FUNCTION**

This kind of cooking is ideal for pizza and vegetable dishes.

With this function, lower heating element, circular heating element and fan motor work at the same time.





<b>Cooking table</b>				
Type of food	Temp. °C	Insertion* guide	Cooking time in minutes	
			Suggested	Personal
<b>Cake in mould with beaten mixture</b>				
Panettone or focaccia	175	2	55 - 65	
Focaccia	175	3	60 - 70	
Cake	175	3	60 - 70	
<b>Pie in mould (short pastry)</b>				
Pie base	200	3	8 - 10	
Pie base with ricotta cheese	200	3	25 - 35	
Pie base with fruit	200	3	25 - 35	
<b>Cake in mould with raised mixture</b>				
Pie base	180	3	30 - 45	
White bread (2,2 lb of flour)	200	3	25 - 35	
<b>Small pastries</b>				
Puff pastry	200	3	10 - 15	
Choux pastry	200	2	35 - 45	
Biscuit pastry	200	3	15 - 20	
<b>Lasagne</b>	225	2	40 - 50	
<b>Meat (cooking time per cm. of thickness)</b>				
Slowly cooked roast (ex. roast veal)	200	2	120 - 150	
Fast cooked roast (ex. roast beef)	200	2	60 - 90	
Meatloaf	200	2	30 - 40	
<b>Poultry</b>				
Duck 3,3 lb	200	2	120 - 180	
Goose 6,6 lb	200	2	150 - 210	
Roast chicken	200	2	60 - 90	
Turkey 11 lb	175	2	about 240	
<b>Game</b>				
Hare	200	2	60 - 90	
Leg of roe	200	2	90 - 150	
Leg of deer	175	2	90 - 180	
<b>Vegetable</b>				
Baked potatoes	220	2	30 - 40	
Vegetable pudding	200	2	40 - 50	
<b>Fish</b>				
Trout	200	2	40 - 50	
Grey mullet	200	2	40 - 50	
<b>Pizza</b>	240	3	10 - 20	
<b>Grill</b>				
Pork chops		4	8 - 12	
Sausages		4	10 - 12	
Grilled chicken		2	25 - 35	
Roast veal on spit (1,3 lb)			50 - 60	
Chicken on spit			60 - 70	
* The guide number refers to the lowest level (excluding the bottom, since it is not possible to insert the drip-pan)				
THE GIVEN ABOVE DATA ARE INDICATIVE BECAUSE THE COOKING TYPE AND TIME VARIES WITH THE FOOD QUANTITY AND QUALITY				



**How to use the grill**

Lay the food in the wire shelf or, in a tray in case of small pieces.

The rack must be positioned in the highest runner possible and the grease drip pan in the runner below. Close the door and turn on the element as follows:

- A. Static oven: adjust selector on position 
- B. Fan oven: adjust selector on position 

C. Multifunction-Fan oven : adjust selector on position 

D. Multifunction oven :adjust selector on position  ,  , 

Each kind of food (fish, poultry etc.) has to be turned over to permit the grilling on both sides.

Under are few cooking suggestions:

Dishes for grilling	Cooking time in minutes		
	Top side		Under side
Slices of thin meat	6		4
Slices of meat of medium thickness	8		5
Slices of thin descaled fish	10		8
Fish (e.g. trout ,salmon)	15		12
Sausages	12		10
Toast	5		2

**How to use the rotisserie (where available)  
- Fig. 2**

It is possible, to use the rotisserie and the grill together.

Meat has to be inserted onto the skewers and blocked by the two clamps.

Proceed now as follows:

- A) Fit the tip of the spit in the hollow shaft of the motor on the back of the oven.
- B) Rest the support in the spit groove.
- C) Unscrew and remove the handgrip.

D) Fit the drip pan in the lowest runner.

E) Set the selector to the grill position  to operate the motor.

F) At the end of cooking, tighten the spit handgrip and take it out of the oven.  
(See Fig. 2).

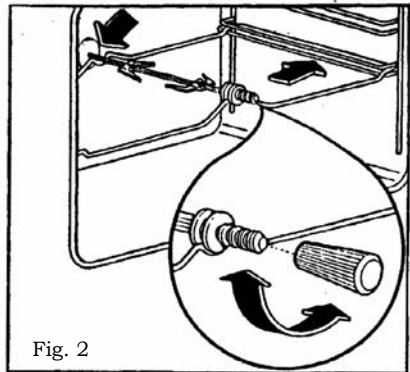

Fig. 2

**Programming your oven with mechanical 60 minutes timer - Fig. 3**

The regulating knob (Fig. 3) must be turned in a clockwise direction until it reaches the 60 minutes position and then turned to the desired time by turning the knob in a counter clockwise direction.

The oven will not be turned off automatically. A minute counter ringing will advise that the cooking time is over.

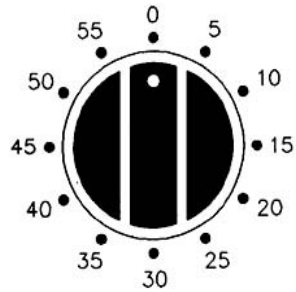

Fig. 3

**Programming your oven with electrical 120 minutes cut-off timer - Fig. 4**

The function of the programming timer is to turn on the oven for a pre-determined amount of time.

**1. OPERATING**

After having set the oven switch knob at the desired temperature, turn the timer knob in a clockwise direction to the desired cooking time (maximum 120 minutes).

When the timer will return to position "0", a minute counter ringing will advise that the oven will automatically turn off.

**2. MANUAL POSITION**

If the cooking time is longer than the 2 hours programme, or if you wish to use the oven manually, to turn it off when you desire, turn the knob to position  (Fig. 4).

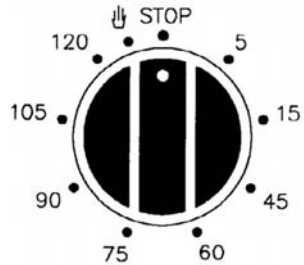

Fig. 4

### Analog programmer - Fig.5

Regulate time by pressing and turning the knob "A" anti-clockwise.

Select the beginning of cooking time by pulling and turning the knob "A" anti-clockwise until the index "B" coincides with the desired time of cooking beginning.

Select the end of cooking time by turning the knob "A" anti-clockwise until the desired time (max 180') coincides with the fixed index (corresponding to XII).

At the end of cooking the oven automatically stops and a bell sounds until the knob "A" is turned to the symbol ☒ .

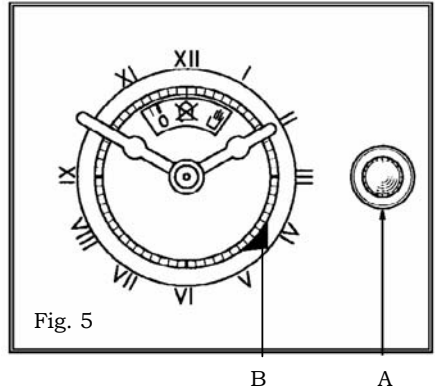

If you want to use the oven excluding the programmer (manual running) turn the knob "A" until the symbol ☞ coincides with the fixed index.

### Analog timer - Fig.6

Setting the clock: to set the clock, press and turn the knob "A" in a clockwise or anticlockwise direction.

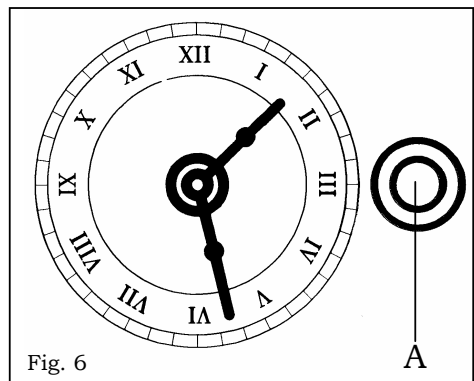

### Electronic programmer - Fig. 7

The electronic programmer is a device which groups together the following functions:

- 24 hours clock with illuminated display
- Timer (up to 23 hours and 59 min.)
- Program for automatic beginning and end of cooking
- Program for semi-automatic cooking (either start or finish only).

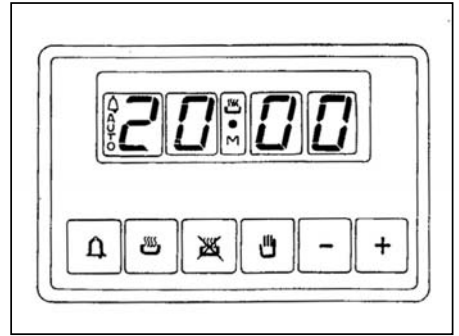

Fig. 7

### Description of buttons



“ TIMER ”



“ COOKING TIME ”



“ END OF COOKING TIME ”



“ MANUAL POSITION ”



“ ADVANCEMENT OF THE NUMBERS OF ALL PROGRAMS ”



“ TURNING BACK OF THE NUMBERS OF ALL PROGRAMS ”

### Description of lighted symbols

« AUTO » - (flashing) - Programmer in automatic position but not programmed.

« AUTO » - (always lighted) - Programmer in automatic position with inserted program.



Automatic cooking taking place



Timer in operation





and « AUTO » (both flashing) – Program Error.

No lighted symbol except clock numbers: programmer on manual set.

## Digital clock

Clock numbers show hours (0-24) and minutes.

Upon immediate hooking up of the oven or after a blackout, three zeros will flash on the programmer panel.



To set the hour it is necessary to push simultaneously the  +  buttons and AT THE SAME TIME to push the [+] button or [-] until you have set the exact hour. The regulation speed depends on the pressure exercised on the [+] [-] buttons.

## Manual cooking without using the programmer

To use manually the oven, that is, without the auxiliary programmer, it is necessary to cancel the flashing «AUTO» by pushing the  button.



If «AUTO» is always flashing (it means a cooking program is still memorized) it is necessary to cancel the inserted cooking program by pushing the  button until setting the clock on zero.

## Automatic cooking (start and end)

- 1) Set the length of cooking time by pushing the  button.
- 2) Set the end of cooking time by pushing the  button.
- 3) Set temperature and cooking program by using the thermostat knob and the selector knob.

After this setting the symbol «AUTO» will flash, this means the oven has been programmed.

An example: cooking lasts 45 minutes and is expected to stop at 14.00.

- Push  until having set 0.45.
- Push  until having set 14.00.

After having finished the setting, the clock hour will appear on the panel and «AUTO» symbol will flash permanently. This means the cooking program has been memorized.

At 13.15 h. (14.00 h. minus 45 minutes ) the oven turns on automatically. During cooking time the  button and «AUTO» are flashing.

At 14.00 h. the oven turns off automatically, a buzzer goes on until it is stopped by pushing the  button.



## Semi-automatic cooking

### A. Set the length of cooking time



#### B. Set the end of cooking time

A) Set the length of cooking time by pushing the  button. The oven will turn on immediately.

«AUTO» and the  symbols will light. When the set cooking time has elapsed, the oven will turn off, a buzzer will ring until it is stopped as above described.

B) Set the end of cooking time by pushing the  button. The oven will turn on immediately. «AUTO» and  will light. At the set time, the oven will turn off and a buzzer will ring until it is stopped as above described.

The cooking program may be seen at any moment by pushing the corresponding button.

The cooking program may be cancelled at any moment by pushing the  until zero appears on the display. Then by pushing the  button the oven can work manually.



## Timer = buzzer

The timer program consists only of a buzzer which may be set for a maximum period of 23 hours and 59 min.

To set the timer, push the  button and, at the same time, [ + ] or [ - ] until you read the desired time on the display.

After the setting, the clock hour and the  symbol will appear.

The countdown will start immediately and may be seen at any moment on the display by simply pressing the  button.

At the end of the set time, the  symbol will turn off and the buzzer will ring until it is stopped by pressing the  button.

**ATTENTION!** An energy blackout makes the clock go to zero and cancels the set programs.

After a blackout three zeros will flash on the panel and cooking can be programmed once again.

## USING THE ELECTRONIC PROGRAMMER

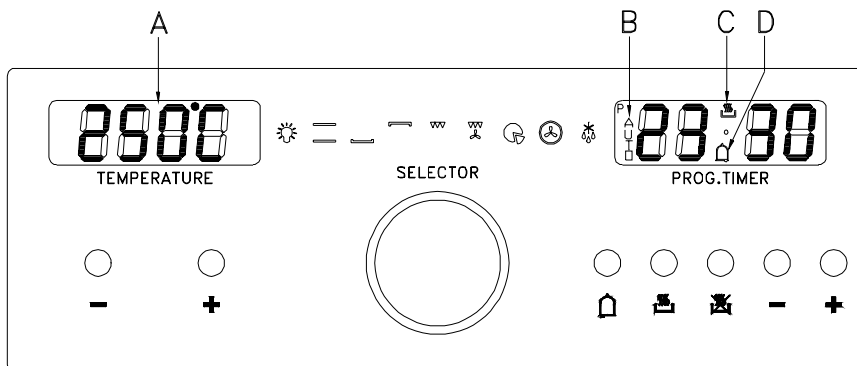

A Temperature



B Automatic programme

C Duration and manual mode

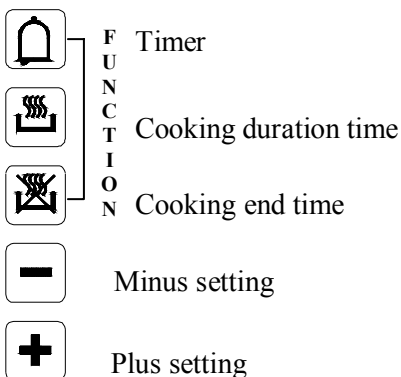

D Minute minder



### Setting the clock

Switch the oven on; 00.00 will appear in blinking mode on the display. To set the clock, simultaneously press the duration  and end of cooking  keys together. Using the +/- keys on the right, select the time of day required. With the key “+” the time increases, with the key “-” the time decreases at a speed directly proportional to the duration of the pressure exerted on the key. When the time is stored, the point between the hours and the minutes will stop blinking approximately 7 seconds after the last operation. To update the time, repeat the operation.

### Manual operation

Press duration  and end time button  together. If an automatic program is on the “AUTO” symbol (B) will be erased, the pot symbol (C) is illuminated. Any programme which has been previously set is cancelled.





## Semiautomatic operation with cooking duration

Select cooking duration function  and set required duration with the +/- keys on the right. “AUTO” (B) and cookpot (C) symbols appear. If time of day = cooking end time the relay output and the cookpot symbol (C) are switched off. The audible signal sounds. The symbol “AUTO” (B) blinks. The cooking will be finished.

## Semiautomatic operation with cooking end time



Select cooking end time function  and set required end time using the +/- keys on the right. The “AUTO” (B) and cookpot (C) symbols appear. Turn the switch knob and the thermostat knob to the cooking function and to the desired temperature. If time of day = cooking end time the oven doesn't heat any longer and the cookpot symbol (C) are switched off. The audible signal sounds and “AUTO” (B) blinks.

## Fully automatic operation

- 1) Set the length of cooking time by pushing the  button and the +/- keys on the right.
- 2) Set the end of cooking time by pushing the  button and the +/- keys on the right.
- 3) Set temperature and cooking program by using the thermostat knob and the selector knob.

After this setting the symbol “AUTO” (B) will appear, this means the oven has been programmed. When the time in the display is the same of the cooking start time the cookpot symbol (C) will appear and the oven will start to work.

Cooking Start Time = Cooking End Time – Cooking Duration Time  
An example: cooking lasts 45 minutes and is expected to stop at 14.00.



- Push  and “+” key on the right until having set 0.45.
- Push  and “+” key on the right until having set 14.00.

After having finished the setting, the clock hour will appear on the panel and “AUTO” symbol (B) will flash permanently. This means the cooking program has been memorized.



At 13.15 h. (14.00 h. minus 45 minutes ) the oven turns on automatically. During cooking time the cookpot button (C) and “AUTO” (B) switch on.

At 14.00 h. the oven turns off automatically, “AUTO” (B) flashes. The cookpot button (C) switches off and a buzzer goes on until it is stopped.

### **Minute counter**

Select the minute counter function  . The fixed time is set at 5 min.; to change it, press the keys +/- on the right. When the point between the hours and minutes and the symbol  begin to blink, it means that the countdown has begun. The display shows the hour and the minutes of the countdown; by pressing the symbol  you can choose whether to display the countdown or the time.

### **Audible signal**

The audible signal sounds at the end of a minute counter cycle  or of a cooking programme  for a period of 7 minutes. To turn it off just press any program input key (the first three on the left ).

You can also regulate the sound level of the audio signal, selecting a more pleasing level, by pressing the symbol “-” on the right for about 2 seconds when you see the time on the display.



### **Program start and control**

Press the cooking duration key  or the end-of-cooking time key  to know the remaining time period.

### **Input error signal**

When a data input is mistaken the audio signal sounds and the symbol “AUTO” (B) flashes.

### **Cancelling a program**

A program can be cancelled pushing at the same time the button  and .

## Switch functions

The following functions can be set by turning the switch knob.

### The following will be shown on the display:



Light



190°C



50°C



190°C



250°C



165°C



165°C



165°C



Defrost

The temperature shown on the display can be changed via the keys +/- on the left. Increase or decrease is in 5°C steps, from a minimum of 40°C to a maximum of 250°C. The symbol °C will blink until the required temperature is reached.

### Replacing the oven light - Fig. 8

The oven is equipped with a lamp having the following features:

25W

screw cap E-14

T 300° C

**WARNING:** disconnect the appliance from the power supply.

If the oven light needs to be replaced, the protective cover «A» must be removed by turning it anticlockwise. After the light has been replaced, refit the protective cover «A». (Fig. 8).

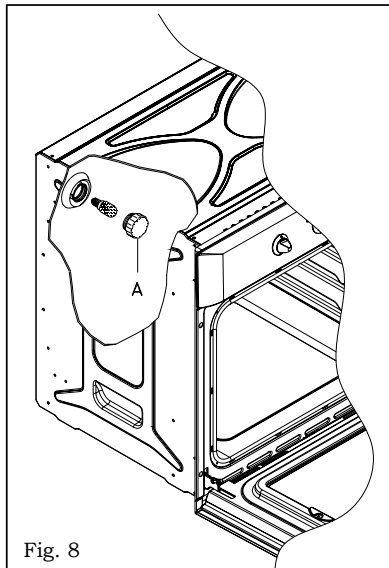

Fig. 8

### Removing the oven door - Fig. 9

To aid cleaning and make access to the oven interior easier, the oven door can be simply removed.

To facilitate cleaning of the oven, the door can be removed via the hinges as follows:

#### hinges with movable bolt

The hinges A are provided with two movable bolts B.

When bolt B is raised, the hinge is released from its housing.

Having done this, the door must be lifted upwards and removed, sliding it towards the outside;

grip the sides of the door near the hinges when performing these operations.

To refit the door, firstly slide the hinges into their slots.

Before closing the door, **remember to rotate the two movable bolts B** used to hook the two hinges.

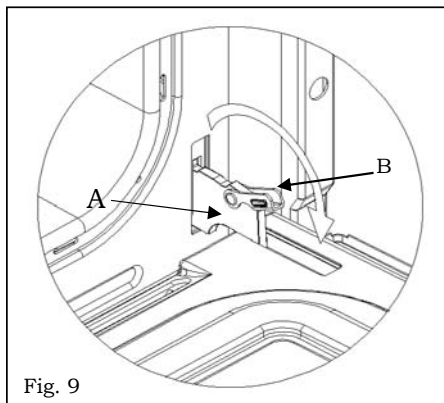

Fig. 9

**Installation of the self-cleaning liners (optional)**

**-Fig. 10**

- 1) Fix the wall (A) with four auto-tapping screws.
- 2) Lean the walls (C ) against the side of the oven and refasten the guides which were earlier taken away.
- 3) Replace the accessories into the oven.

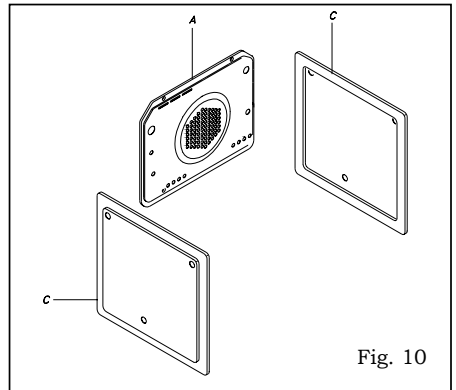

Fig. 10

**Oven accessories - Fig. 11**

The appliance can be equipped with lateral guides which have to be fixed on the oven side. Slide oven shelves and trays on lateral guides.

Lateral guides can be removed by a light downwards pressure on device A.

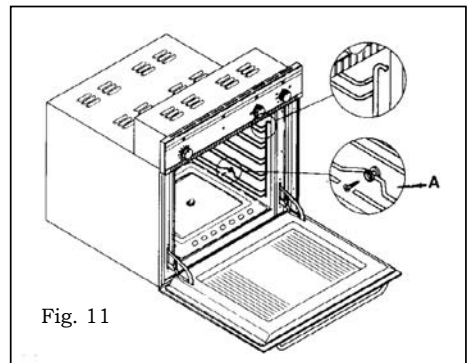

Fig. 11

## **Cleaning and maintenance**

**Important:** The cleaning of the appliance must be carried out after the power supply has been disconnected.

**How to clean the oven:** The cleaning of the oven, with no self-cleaning panels, has to be carried out after cooking, whilst the oven is still lukewarm (**not hot**), so that the food spillages on the oven surface can be removed easily. Remove the lateral guides, pulling their front side and unhooking them.

Wipe the inside of the oven by using a damp cloth with a diluted ammonia product; rinse and dry the oven.

In case of persistent marks, leave a soaking ammonia cloth at the bottom of the oven muffle for some hours with the door closed; then wash away with warm water and liquid detergent.

Rinse and dry carefully. For external parts, use a soft cloth and soapy water, rinse and dry carefully.

Do not use abrasives, bleach or coarse cleaning material.

**The Manufacturer declines responsibility for damages to persons or things due to a bad or improper installation of the appliance.**

**Owing to our policy of continuous improvements, we reserve the right to adjust and modify our product without prior notification.**