

INSTRUCTIONS FOR STEAM OVEN INSTALLATION  
AND USE

INSTRUCCIONES DE INSTALACIÓN Y USO DEL  
HORNO A VAPOR

INSTRUÇÕES PARA A INSTALAÇÃO E O USO DO  
FORNO A VAPOR

ISTRUZIONI PER L' INSTALLAZIONE E L'USO  
DEL FORNO A VAPORE

INSTALLATIONS-UND GEBRAUCHSANWEISUNG  
DES DAMPFBACKOFENS

MANUEL D' INSTALLATION ET D'EMPLOI  
DU FOUR A VAPEUR

**D** In Übereinstimmung mit den Anforderungen der Europäischen Richtlinie 2002/96/EG über Elektro- und Elektronik-Altgeräte (WEEE) ist vorliegendes Gerät mit einer Markierung versehen. Sie leisten einen positiven Beitrag für den Schutz der Umwelt und die Gesundheit des Menschen, wenn Sie dieses Gerät einer gesonderten Abfallsammlung zuführen. Im unsortierten Siedlungsmüll könnte ein solches Gerät durch unsachgemäße Entsorgung negative Konsequenzen nach sich ziehen. Auf dem Produkt oder der beiliegenden Produktdokumentation ist

folgendes Symbol  einer durchgestrichenen Abfalltonne abgebildet. Es weist darauf hin, dass eine Entsorgung im normalen Haushaltsabfall nicht zulässig ist. Entsorgen Sie dieses Produkt im Recyclinghof mit einer getrennten Sammlung für Elektro- und Elektronikgeräte. Die Entsorgung muss gemäß den örtlichen Bestimmungen zur Abfallbeseitigung erfolgen. Bitte wenden Sie sich an die zuständigen Behörden Ihrer Gemeindeverwaltung, an den lokalen Recyclinghof für Haushaltsmüll oder an den Händler, bei dem Sie dieses Gerät erworben haben, um weitere Informationen über Behandlung, Verwertung und Wiederverwendung dieses Produkts zu erhalten.

**GB** This appliance is marked according to the European directive 2002/96/EC on Waste Electrical and Electronic Equipment (WEEE). By ensuring this product is disposed of correctly, you will help prevent potential negative consequences for the environment and human health, which could otherwise be caused by inappropriate waste handling of this product.

The symbol  on the product, or on the documents accompanying the product, indicates that this appliance may not be treated as household waste. Instead it shall be handed over to the applicable collection point for the recycling of electrical and electronic equipment. Disposal must be carried out in accordance with local environmental regulations for waste disposal. For more detailed information about treatment, recovery and recycling of this product, please contact your local city office, your household waste disposal service or the shop where you purchased the product.

**F** Cet appareil porte le symbole du recyclage conformément à la Directive Européenne 2002/96/CE concernant les Déchets d'Équipements Électriques et Électroniques (DEEE ou WEEE). En procédant correctement à la mise au rebut de cet appareil, vous contribuerez à empêcher toute conséquence nuisible pour l'environnement et la santé de l'homme.

Le symbole  présent sur l'appareil ou sur la documentation qui l'accompagne indique que ce produit ne peut en aucun cas être traité comme déchet ménager. Il doit par conséquent être remis à un centre de collecte des déchets chargé du recyclage des équipements électriques et électroniques. Pour la mise au rebut, respectez les normes relatives à l'élimination des déchets en vigueur dans le pays d'installation. Pour obtenir de plus amples détails au sujet du traitement, de la récupération et du recyclage de cet appareil, veuillez vous adresser au bureau compétent de votre commune, à la société de collecte des déchets ou directement à votre revendeur.

**NL** Dit apparaat is voorzien van het merkteken volgens de Europese richtlijn 2002/96/EG inzake Afgedankte elektrische en elektronische apparaten (AEEA). Door ervoor te zorgen dat dit product op de juiste manier als afval wordt verwerkt, helpt u mogelijk negatieve consequenties voor het milieu en de menselijke gezondheid te voorkomen die anders zouden kunnen worden veroorzaakt door onjuiste verwerking van dit product als afval.

Het symbool  op het product of op de bijbehorende documentatie geeft aan dat dit product niet als huishoudelijk afval mag worden behandeld. In plaats daarvan moet het worden afgegeven bij een verzamelpunt voor recycling van elektrische en elektronische apparaten. Afdanking moet worden uitgevoerd in overeenstemming met de plaatselijke milieuvorschriften voor afvalverwerking. Voor nadere informatie over de behandeling, terugwinning en recycling van dit product wordt u verzocht contact op te nemen met het stadskantoor in uw woonplaats, uw afvalophaaldienst of de winkel waar u het product heeft aangeschaft.

**E** Este aparato lleva el marcado CE en conformidad con la Directiva 2002/96/EC del Parlamento Europeo y del Consejo sobre residuos de aparatos eléctricos y electrónicos (RAEE). La correcta eliminación de este producto evita consecuencias negativas para el medioambiente y la salud.

El símbolo  en el producto o en los documentos que se incluyen con el producto, indica que no se puede tratar como residuo doméstico. Es necesario entregarlo en un punto de recogida para reciclar aparatos eléctricos y electrónicos. Deséchelo con arreglo a las normas medioambientales para eliminación de residuos.

Para obtener información más detallada sobre el tratamiento, recuperación y reciclaje de este producto, póngase en contacto con el ayuntamiento, con el servicio de eliminación de residuos urbanos o la tienda donde adquirió el producto.

**P** Este aparelho está classificado de acordo com a Directiva Europeia 2002/96/EC sobre Resíduos de equipamento eléctrico e electrónico (REEE).

Ao garantir a eliminação adequada deste produto, estará a ajudar a evitar potenciais consequências negativas para o ambiente e para a saúde pública, que poderiam derivar de um manuseamento de desperdícios inadequado deste produto.

O símbolo  no produto, ou nos documentos que acompanham o produto, indica que este aparelho não pode receber um tratamento semelhante ao de um desperdício doméstico.

Pelo contrário, deverá ser depositado no respectivo centro de recolha para a reciclagem de equipamento eléctrico e electrónico. A eliminação deverá ser efectuada em conformidade com as normas ambientais locais para a eliminação de desperdícios.

Para obter informações mais detalhadas sobre o tratamento, a recuperação e a reciclagem deste produto, contacte o Departamento na sua localidade, o seu serviço de eliminação de desperdícios domésticos ou a loja onde adquiriu o produto.

**I** Questo apparecchio è contrassegnato in conformità alla Direttiva Europea 2002/96/EC, Waste Electrical and Electronic Equipment (WEEE). Assicurandosi che questo prodotto sia smaltito in modo corretto, l'utente contribuisce a prevenire le potenziali conseguenze negative per l'ambiente e la salute.

Il simbolo  sul prodotto, o sulla documentazione di accompagnamento, indica che questo prodotto non deve essere trattato come rifiuto domestico ma deve essere consegnato presso l'idoneo punto di raccolta per il riciclaggio di apparecchiature elettriche ed elettroniche.

Disfarsene seguendo le normative locali per lo smaltimento dei rifiuti. Per ulteriori informazioni sul trattamento, recupero e riciclaggio di questo prodotto, contattare l'idoneo ufficio locale, il servizio di raccolta dei rifiuti domestici o il negozio presso il quale il prodotto è stato acquistato.

Contents

<b>INTRODUCTION</b> .....	5
<b>OVEN DESCRIPTION</b> .....	5
<b>WARNINGS</b> .....	6
<b>INSTALLATION</b> .....	7
Connection to the mains power supply .....	7
Replacement of the power cord: .....	7
Terminal box .....	7
Oven preparation and pre-use .....	8
<b>CLEANING AND MAINTENANCE OF OVEN AND ACCESSORIES</b> .....	8
<b>INSTRUCTIONS FOR CORRECT INSTALLATION</b> .....	9
<b>TECHNICAL DATA</b> .....	9
Oven dimensions .....	10
<b>DESCRIPTION OF THE OVEN AND ACCESSORIES</b> .....	11
<b>DESCRIPTION of the CONTROL PANEL</b> .....	12
Description of the keys .....	12
<b>FIRST START-UP</b> .....	13
<b>HOW TO TURN THE OVEN ON</b> .....	13
<b>HOW TO TURN THE OVEN OFF</b> .....	13
<b>COOKING CYCLES AVAILABLE</b> .....	14
<b>HOW TO SELECT A COOKING FUNCTION</b> .....	15
<b>USING A COOKING FUNCTION THAT INCLUDES STEAM</b> .....	15
<b>USING A COOKING FUNCTION THAT DOES NOT INCLUDE STEAM</b> .....	15
<b>HOW TO CHANGE THE COOKING CHAMBER TEMPERATURE</b> .....	16
<b>HOW TO START THE COOKING</b> .....	16
<b>HOW TO USE THE ALARM FUNCTION</b> .....	16
<b>HOW TO DISPLAY OR CHANGE THE ALARM STATUS</b> .....	17
How to reset the alarm function .....	17
<b>HOW TO PROGRAM THE OVEN</b> .....	17
<b>HOW TO SET OR CHANGE THE COOKING TIME</b> .....	17
<b>HOW TO CANCEL A COOKING TIME</b> .....	17
<b>HOW TO PROGRAM THE START AND STOP OF THE OVEN</b> .....	18
<b>HOW TO CANCEL AN OVEN START/STOP PROGRAM</b> .....	18
<b>COOKING FINISHED MODE</b> .....	18
<b>COOKING WITH THE FOOD PROBE</b> .....	19
How to use the food probe .....	19
<b>HOW TO CHANGE THE FOOD PROBE TEMPERATURE</b> .....	20
<b>USING THE FOOD PROBE AS A THERMOMETER</b> .....	20
<b>HOW TO PROGRAM THE START OF THE OVEN USING THE FOOD PROBE</b> .....	20
<b>SAVING A COOKING CYCLE</b> .....	21
<b>HOW TO SAVE A COOKING CYCLE</b> .....	21
<b>HOW TO ADD STEAM IN THE HOT AIR + STEAM COOKING MODE</b> .....	22
<b>HOW TO MOVE AROUND INSIDE THE MENU</b> .....	23
<b>MENU STRUCTURE FLOW-CHART</b> .....	24
BREAD/PIZZA recipe list .....	25
TIMBALES recipe list .....	25
MEAT recipe list .....	26
FISH recipe list .....	27
VEGETABLES recipe list .....	27
DESSERTS recipe list .....	28

<b>HOW TO PERSONALIZE THE RECIPE LIST .....</b>	<b>28</b>
<b>HOW TO LOAD YOUR OWN RECIPE .....</b>	<b>28</b>
<b>HOW TO DELETE YOUR OWN RECIPE .....</b>	<b>28</b>
<b>PRACTICAL COOKING SUGGESTIONS .....</b>	<b>30</b>
<b>ACCESSORIES .....</b>	<b>30</b>
Drip pan .....	30
Grill .....	30
Perforated drip pan .....	30
FOOD probe .....	31
<b>HOW TO PERSONALIZE YOUR OVEN .....</b>	<b>31</b>
<b>SETTING THE CLOCK .....</b>	<b>31</b>
<b>SETTING KEYPAD LOCK .....</b>	<b>32</b>
<b>HOW TO DEACTIVATE THE KEYPAD LOCK .....</b>	<b>32</b>
<b>KEYPAD LOCK DETAILS .....</b>	<b>33</b>
<b>BUZZER .....</b>	<b>33</b>
<b>LIGHTING .....</b>	<b>33</b>
<b>WATER HARDNESS .....</b>	<b>33</b>
<b>START CLEANING CYCLE .....</b>	<b>34</b>
COOKING CHAMBER .....	34
BOILER DESCALING .....	34
Suitable descaler: .....	34
INSTRUCTIONS for boiler descaling process: .....	35
Boiler wash .....	35
<b>RESET SETTINGS .....</b>	<b>36</b>
<b>OVEN OFF MODE .....</b>	<b>37</b>
<b>COOKING FINISHED MODE .....</b>	<b>37</b>
<b>WHAT TO DO IN CASE OF AN ANOMALY .....</b>	<b>38</b>
<b>WHAT TO DO IN CASE OF A BLACK-OUT .....</b>	<b>38</b>
<b>ERROR CODES TABLE .....</b>	<b>39</b>
<b>HOW TO DISASSEMBLE THE SIDE GRILLS .....</b>	<b>40</b>
<b>HOW TO REASSEMBLE THE SIDE GRILLS .....</b>	<b>40</b>
<b>HOW TO CHANGE THE OVEN LIGHT BULB .....</b>	<b>41</b>
Instruction for changing the light bulb: .....	41
<b>HOW TO CHANGE THE COOKING CHAMBER SEAL .....</b>	<b>41</b>
<b>HOW TO DISASSEMBLE THE OVEN DOOR .....</b>	<b>42</b>
<b>HOW TO REASSEMBLE THE OVEN DOOR .....</b>	<b>43</b>
<b>OVEN DETAILS .....</b>	<b>43</b>
Touch-Control Keypad .....	43
Keypad command inactivity .....	43
‘Beep’ Signal .....	43
Cooling fan .....	43
Golden colour of the cooking chamber .....	43
<b>SYSTEM WARNINGS: .....</b>	<b>44</b>
CHECK THAT THERE IS WATER IN THE PITCHER .....	44
INSERT THE PITCHER .....	44
CONNECT FOOD PROBE .....	44
DISCONNECT FOOD PROBE .....	44
CLOSE THE DOOR .....	44
BOILER EMPTYING .....	44
WAIT .....	44
<b>DISPOSAL .....</b>	<b>45</b>
Packaging .....	45
Oven: .....	45

## INTRODUCTION -

### OVEN DESCRIPTION

Combination oven suitable for cooking food in ordinary homes for non-professional purposes combining, in a single product, traditional cooking with the advantages of steam to obtain excellent results for each meat, fish, vegetable and dessert dish while at the same time retaining the taste, freshness, aromas and above all the nutritional properties of the food. This oven is not suitable for other purposes.

Install and use the appliance in rooms with temperatures that do not fall below 5°C.

### WARNINGS

- This appliance is designed to be used by adults who are familiar with these user instructions.
- Make sure that the power cord of the electrical appliances is not crushed by the oven door. The electrical insulation could be damaged.
- If the power cord has been damaged, it must be replaced by customer service to prevent danger.
- Children are often unable to recognize the risks entailed in using the appliance. Please supervise children properly and do not let them play with the appliance.
- Heat forms during cooking and the appliance door, can become very hot. Do not touch the door and keep children away.
- Individuals who are disabled or not self-sufficient must be assisted by capable adults.
- During use, the accessible parts of the oven may become very hot. Keep children away from the oven until the appliance has cooled.
- **When opening the oven door during or upon completion of the cooking phase, be careful of the flow of hot air and/or steam coming out of the cooking chamber. Step back or to the side to avoid burns.**
- It is advisable to use distilled water in order to reduce the formation of scale.
- Install and use the appliance in rooms with temperatures that do **not fall below 5°C**.
- Do not use the oven to heat the room.
- Before closing the oven door, make sure there are no foreign objects or pets inside the oven.
- Do not store flammable materials or temperature-sensitive objects such as cleansers, sprays, vacuum packed containers, canned food, etc. in the oven. This presents a fire / explosion risk.
- Preserve this manual carefully and keep it handy so that you can consult it whenever necessary. If you sell or give the appliance to another person do not forget to attach this manual to the appliance.
- As soon as an operating problem is discovered, the oven must be unplugged.
- Hot grease and fat catch fire easily. It is dangerous to heat oil in the oven to cook meat and this should be avoided. Never try to put out a grease fire using water (there may be an explosion). Suffocate the flames with wet cloths.
- The grill, plates and cooking containers become very hot. When inserting or removing them, use oven gloves or pot holders which are completely dry.

- When using or cleaning the oven, be careful not to place your fingers in the door hinges or in the door itself in order to avoid crushing or injuries. Be especially careful of this when children are present.
- Leave the oven door open in the supported position only.
- When the door is open, there is a risk of tripping or crushing fingers.
- Do not sit or lean on the oven door, and do not use it as a work surface.
- For maintenance, moving, installation and cleaning of the appliance, use suitable prevention and protection equipment (gloves, etc.).
- Lifting and moving of appliances weighing more than 25 kg must be carried out using proper equipment, or by two persons, in order to avoid risks or injuries.
- Any work on the appliance must be done with the appliance disconnected from the electrical power supply.  
It is not permitted to modify, tamper with or attempt repairs on the appliance, especially with tools (screwdrivers and the like), either inside or outside the appliance.  
Repairs must only be carried out by authorized personnel, especially on the electrical parts. Inappropriate repair work may cause serious accidents, damage the appliance and equipment and lead to improper operation.
- Appliances repaired in technical service centres must undergo routine testing, especially concerning the earth circuit continuity.
- Use only the food / temperature probe included in the oven accessories. If the food probe breaks or becomes lost, contact your nearest Authorized Service Centre.

- |   |
|---|
| <ul style="list-style-type: none"> <li>• The manufacturer shall not be held liable for damage to persons or property due to poor or incorrect maintenance of the appliance.</li> <li>• The manufacturing company declines all responsibility if the safety standards are not observed.</li> <li>• The manufacturer reserves the right to make any modifications to its products which it feels are necessary or useful without any advance notice.</li> </ul> |
|---|

## INSTALLATION

**Remove the appliance from the package and check that the product and power cord are NOT damaged.**

Otherwise, contact the retailer before operating the appliance.

Do not lift the product by the door handle. Packaging (e.g. paper, polystyrene) may be hazardous to children (danger of suffocation). Keep packaging out of the reach of children.

The product must be installed and connected correctly to the mains power supply, following the manufacturer's instructions and only by **QUALIFIED PERSONNEL**. Before performing any type of work, it must be verified that the appliance is **DISCONNECTED** from the mains power supply.

### Connection to the mains power supply

- Make sure the voltage matches that indicated on the typeplate which can be viewed by opening the oven door.
- Check whether there is an omnipolar switch available on the domestic line which is compliant with current standards (3 mm minimum opening distance between contacts) and if it is able to support the load of the appliance (see the typeplate). Otherwise place a device, easily reachable, between the appliance and the electricity line with the described specifications.
- **CAUTION:** Check whether your electrical system is equipped with an efficient earth connection according to current standards and legal provisions. N.B. The earth connection is required by law.
- The yellow/green earth cable must not be interrupted by the switch and must be 23 cm longer than the other cables.
- Do not position the power cord near sources of heat or at temperatures more than 50° above the room temperature.

- If the appliance is lacking the power cord, the oven must be connected to the mains power supply with a cable having a minimum section of 1.5mm<sup>2</sup>.
- If a plug is to be used, it must be a standard plug suitable for the load and the power outlet.

### Replacement of the power cord:

If the power cord needs to be replaced, use cables of the following type only:  
H05 RR-F, H05 V2V2-F(T-90)  
Wire sections 3x1.5mm<sup>2</sup>

### Terminal box

The oven is equipped with a terminal box set up for operation with a single-phase 220-240 Vac 50 Hz supply voltage.

*Picture of the open terminal box showing the connected wires.*

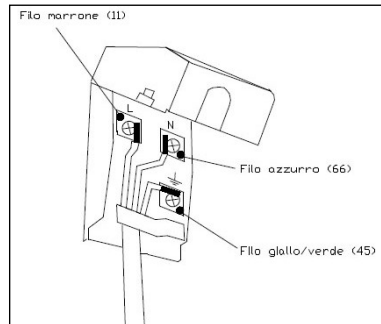

### *Oven preparation and pre-use*

N.B. Disconnect the oven from the mains power, or move the omnipolar switch to OFF, before cleaning the oven.

Before using the oven, thoroughly clean the inside using a soft cloth or nonabrasive sponge dampened with warm water and washingup liquid. Insert the grill and drip pan in their respective tracks.

Turn on the oven, see page 14 select the "Professional Cooking" function , see page 16 and set the temperature to 230°C. Operate the oven empty for about 30 minutes in order to remove any residues of manufacturing oil or grease which can produce unpleasant odours during cooking. Air the room during this operation.

### **CLEANING AND MAINTENANCE OF OVEN AND ACCESSORIES**

- To facilitate the cooking chamber cleaning operations, it is advisable to use the automatic process described on page 35
- Then it is advised to disconnect the appliance from the mains power supply.
- 
- Use a damp sponge to remove any residues from the chamber walls after each use.
- Do not use steam cleaners to clean the oven.
- Do not use coarse abrasive material such as scourers, metal scrapers or steel wool to clean the glass of the oven door in order to avoid scratches that may cause the glass to shatter.
- **DO NOT WASH THE FOOD PROBE IN THE DISHWASHER.**
- The grill, pitcher and drip pan can be washed in the dishwasher.
- Empty the water pitcher after each use for hygiene reasons.
- After cooking, and when the oven has cooled sufficiently, use a soft cloth to dry any liquid remaining on the bottom of the cooking chamber.



## INSTRUCTIONS FOR CORRECT INSTALLATION

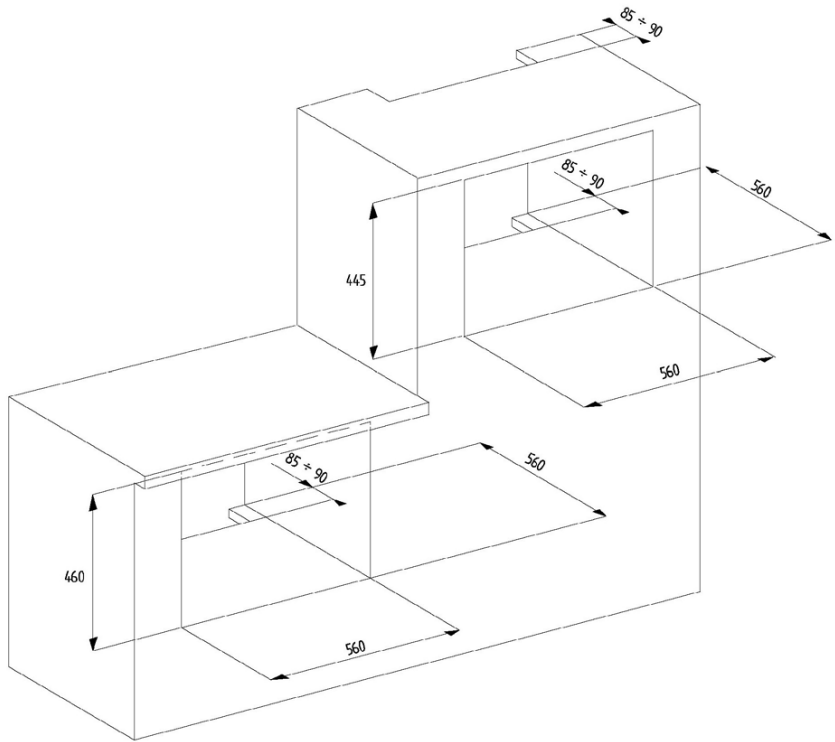

### TECHNICAL DATA

- Water tray capacity: 1.2 L.
- Usable volume (cooking chamber): 27 L.
- Gross volume (cooking chamber): 31 L.
  
- Connection voltage: 220-240V 50Hz
- Maximum pickup voltage: 2.2 KW.

Oven dimensions

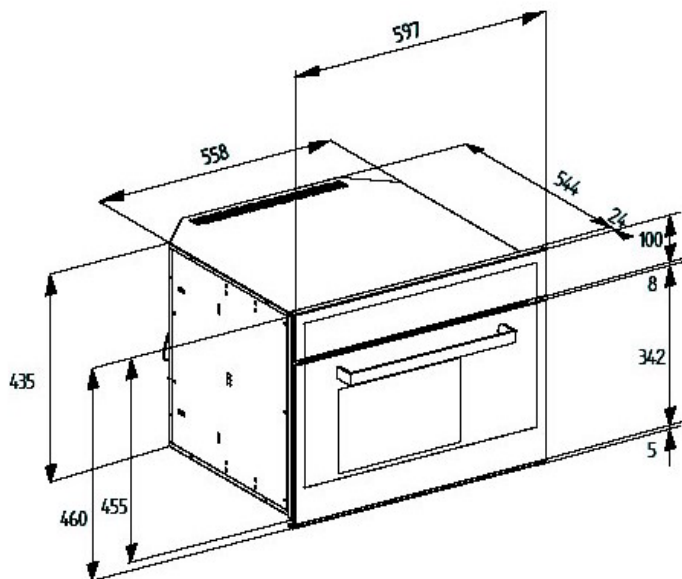
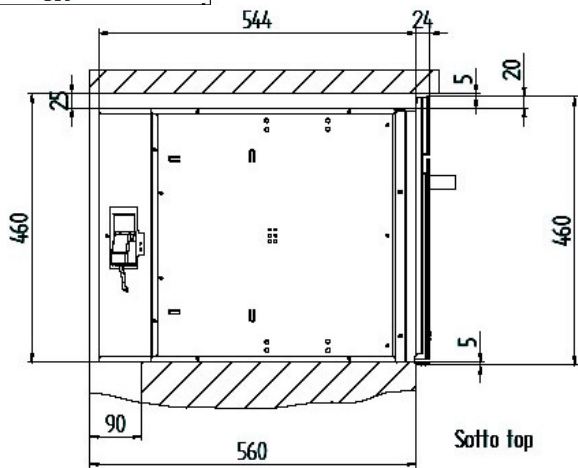
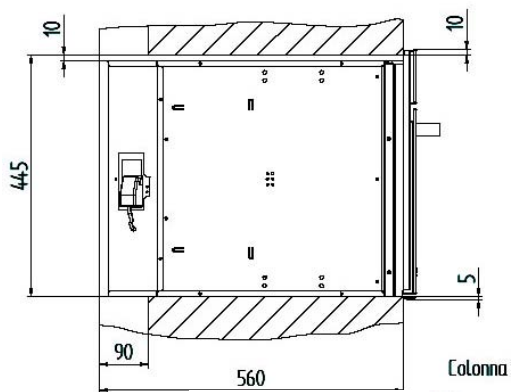

## DESCRIPTION OF THE OVEN AND ACCESSORIES

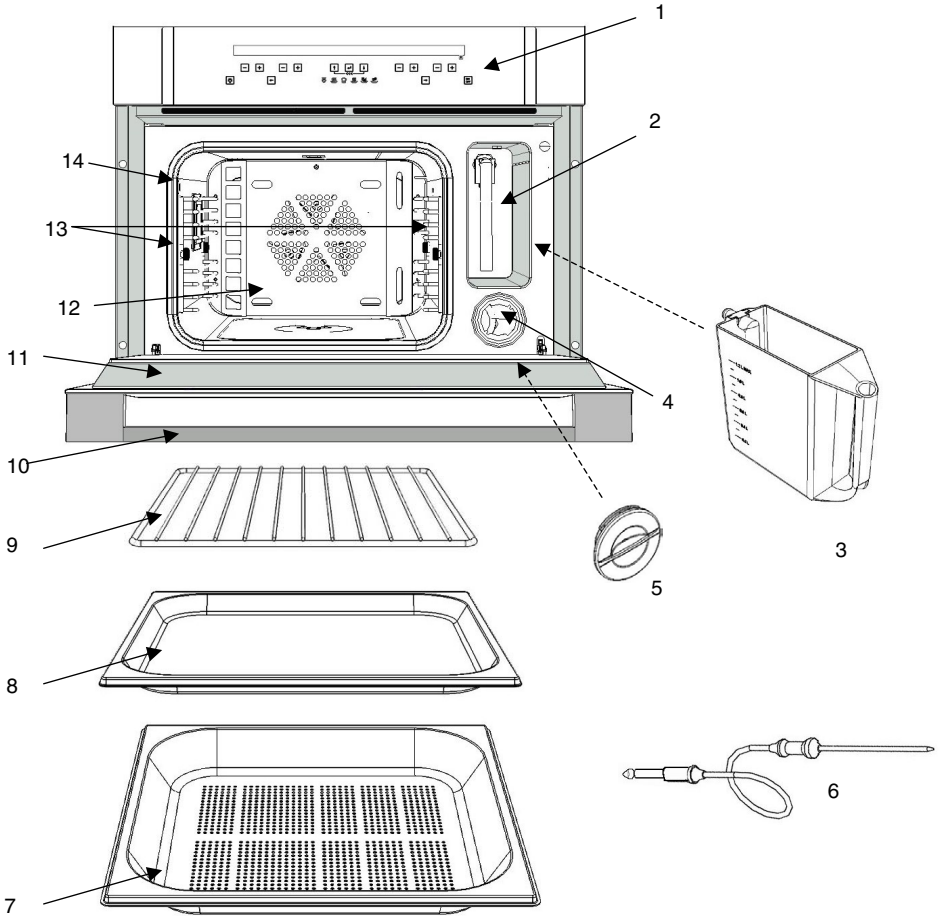

- 1 Control panel and data display
- 2 Pitcher compartment
- 3 Pitcher
- 4 Filter compartment
- 5 Filter cap
- 6 Food or temperature probe
- 7 Perforated drip pan

- 8 Drip pan
- 9 Grill
- 10 Handle
- 11 Door
- 12 Cooking chamber
- 13 Side grills
- 14 Food probe connector

## DESCRIPTION of the CONTROL PANEL

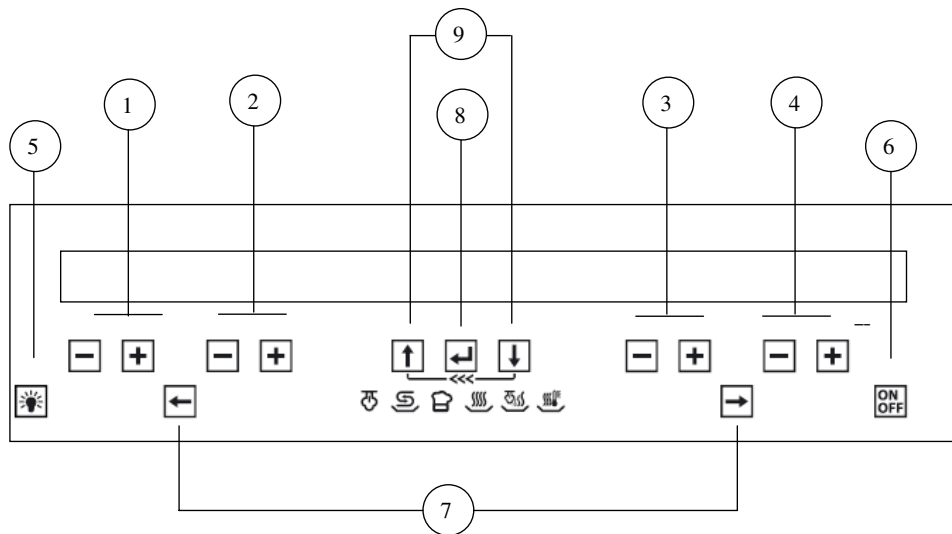

### *Description of the keys*

1. Keys for setting the cooking chamber temperature and display area for the temperature indication  
(+ to increase, - to decrease, min. 30°-max.230° \* depending on the cycle selected, see page 15)
2. Keys for setting the food probe temperature and display area for the food probe temperature indication  
(+ to increase, - to decrease, min. 30°-max.90°)
3. Keys for programming timed events and display area for timing indication
4. Keys for programming the alarm or setting the clock and display area for clock / alarm indication
5. Cooking chamber light on / off key
6. Oven on / off key
7. Cooking function selection keys
8. Selection confirmation key
9. Keys for scrolling the menu items

## FIRST START-UP

When the oven is connected to the mains power supply for the first time, a wait message ( WAIT ) and some product identification information appear on the display.



**Do not touch the keypad during this brief period.**

N.B. It is normal that the Tangential Fan turns on and then shuts off after a few moments.

When the following message appears: LANGUAGE ENGLISH

select the desired language by pressing one of the keys:   (4)

Confirm the selection with key  (8)

Then set the clock using the keys   (4) individually to reach the current time.

Confirm the setting by pressing key  (8)

## HOW TO TURN THE OVEN ON

Press the key  (6) for at least 1 sec.

The writing <<ON>> appears on the display, the oven light turns on and then the following message appears:

← → SELECT COOKING    ↓ MENU

**N.B.** Deactivate the keypad lock if it is active.

See section HOW TO DEACTIVATE THE KEYPAD LOCK page 33

the oven will turn off automatically, after 5 minutes, if no selection is made.









## HOW TO TURN THE OVEN OFF

Press the key  (6).

The writing <<OFF>> appears on the display.

The oven will go into stand-by mode, see section [oven off mode](#) page 38

## COOKING CYCLES AVAILABLE

Function name and symbol	Function description	Min-Max. Chamber temp. T default	Food probe T default
STEAM COOKING 	<p>During steam cooking, the steam coming from the boiler flows into the cooking chamber.</p> <p>The steam heats the cooking chamber and cooks the food. This cooking mode is ideal for cooking any type of vegetables, and it preserves the colour, taste and above all the organoleptic properties of the food.</p>	<p><b>40 – 100</b></p> <p><b>100</b></p>	70
REGENERATION 	<p>Steam and hot air contribute to heating the cooking chamber. The heating of the food is thus quick and homogeneous, preventing it from becoming dry.</p> <p>The element that heats the air is the CIRCULAR heating element. The radial fan distributes the heat uniformly.</p> <p>This mode is suitable for heating previously cooked food (leftovers), precooked food or frozen products.</p>	<p><b>60 – 130</b></p> <p><b>110</b></p>	70
PROFESSIONAL COOKING 	<p>Cooking carried out in several phases.</p> <p>When started, in the first phase, the food is steam cooked. After an automatically determined period of time, the cooking switches to the HOT AIR cooking mode.</p> <p>This cooking system is ideal for rising any type of dough or for cooking dough, bread or focaccia bread.</p> <p>This type of cooking, however, cannot be performed several times in a row, otherwise the results will be less than ideal.</p> <p>The oven must be allowed to cool between two professional cooking cycles. Only in this manner will the new steam phase be carried out properly.</p>	<p><b>100–230</b></p> <p><b>205</b></p>	70
HOT AIR COOKING 	<p>The air inside the cooking chamber is heated by the circular heating element located behind the rear wall of the appliance. The radial fan helps to move the air in a uniform manner. This system, also known as ventilated cooking, cooks the food on every side.</p>	<p><b>40 – 230</b></p> <p><b>175</b></p>	70
HOT AIR + STEAM 	<p>This cooking mode is equivalent to the hot air cooking mode described previously but also allows the possibility to produce steam, at any time, in the cooking chamber by pressing the key  (8) . The production of steam in the cooking chamber is automatically deactivated 10 minutes after its start, or it can be deactivated even earlier, at any time, by pressing the key  (8) again.</p> <p>Ideal for cooking roasts.</p>	<p><b>80 – 230</b></p> <p><b>175</b></p>	70
LOW TEMPERATURE 	<p>Low-temperature cooking system for relatively long time periods. Ideal for cooking meat, producing a tender and delicate meat dish.</p> <p>The air inside the cooking chamber is heated by the circular heating element located behind the rear wall of the appliance and distributed uniformly thanks to the ventilation produced by the radial fan. The cooking must be carried out using the food probe supplied with the oven.</p>	<p><b>60-100</b></p> <p><b>90</b></p>	70

## HOW TO SELECT A COOKING FUNCTION

Press one of the two direction keys:   (7) to select the desired cooking cycle. See function explanation in the table above. (cooking cycles available)

N.B. If no selection is made within 5 minutes, the oven will turn off automatically. See section [oven off mode](#) page 38

## USING A COOKING FUNCTION THAT INCLUDES STEAM

- Fill the water container (pitcher) with distilled water or, if this is unavailable, drinking water.
- Fill the container up to the mark ( 1.2 L.). N.B. NEVER fill the pitcher completely, otherwise the water pumped back into the pitcher at the end of the cooking cycle may overflow.
- Insert the pitcher into its seat.
- Push the pitcher down completely to ensure a perfect seal between the tube located in the pitcher and the hydraulic circuit inside the oven.
- Always insert the NON-perforated drip pan under the perforated drip pan to collect the condensation, juices or parts of food that may fall.



## USING A COOKING FUNCTION THAT DOES NOT INCLUDE STEAM

When the oven is used with a cycle that does not include steam, the container may remain in its seat without compromising the cooking result.

N.B.

In order for the STEAM REGENERATION or PROFESSIONAL cooking modes to be carried out successfully, the oven must be allowed to cool sufficiently if it was previously used for a similar cooking process

## HOW TO CHANGE THE COOKING CHAMBER TEMPERATURE

Press one of the two keys   (1) to change, with steps of +/-5°C, the preset temperature.

The cooking chamber temperature is always displayed on the left side of the letter **f**.

**N.B.** The degree symbol “°” flashes during the oven preheating period until the set temperature is achieved. Otherwise, it is always on in all the other cases, such as for example: temperature control, when the oven is maintaining the temperature already achieved, and cooling, when the oven must reach a set temperature lower than the starting value.

## HOW TO START THE COOKING

The activation of the selected cooking function, with the settings shown on the display, occurs when the selection is confirmed with key  (8).

The following message appears on the display: **↓ ACTIVATE CYCLE ↓ MENU**

**N.B.** The oven turns off automatically after 5 minutes if the start of the cooking process is not confirmed.



The phrase “**COOKING IN PROGRESS ↓ MENU**” will appear on the display when the cooking is activated.

Pressing the key  (9) accesses a menu which allows the user to perform semiautomatic cooking settings or store the data of the cooking in progress. See section **HOW TO PROGRAM THE OVEN** on page 18

## HOW TO USE THE ALARM FUNCTION

Press one of the two keys   (4) to activate the function.

The symbol  begins to flash and the display shows the message: **ALARM** and the digits 00.00 appear.

Use the keys   (4) individually to set the desired time.

The maximum time that can be set is 23 hours and 59 minutes.

After a few moments (5 sec.), the timer begins, the oven returns to displaying the current time and the symbol remains constantly lit.

At the end of the set time period, a buzzer sounds and the following messages displayed:

**ALARM** 00.00 and the symbol  (the last two flashing).

Press any key to stop the buzzer.



*Note: The buzzer is automatically deactivated after 5 minutes.*

### CAUTION:

- The alarm function does NOT interact with the operation of the oven, and its always available regardless of the oven state.





## HOW TO DISPLAY OR CHANGE THE ALARM STATUS

Press one of the two keys   (4) and the display immediately shows the information regarding the time status of the alarm.

The symbol  begins to flash.

Press one of the two keys   (4) to set a new time for the alarm.

### How to reset the alarm function



Press the keys   (4) simultaneously to reset the time previously programmed for this function.

The symbol  will turn off.

## HOW TO PROGRAM THE OVEN

### HOW TO SET OR CHANGE THE COOKING TIME

Turn the oven on and select a cooking function.

Use the keys   (3) to set the cooking time.

The initial display of the time is set in mm.ss, then hh.mm.



(h=hours, m= minutes, s=seconds)

The maximum time that can be set is 10 hours.

Then activate the cooking, see section [how to start the cooking](#) page 17

The time displayed begins to decrease, and when it reaches zero the oven will go into cooking finished mode, see page 38



### HOW TO CANCEL A COOKING TIME

Press the keys   (3) simultaneously to cancel the time previously programmed for this function.



The cooking time is set to zero.



## HOW TO PROGRAM THE START AND STOP OF THE OVEN

Turn on the oven, select a cooking function and set the desired cooking temperature.

Use the keys   (3) to set the cooking time.

The maximum time that can be set is 10 hours.

Then press the key:  (9), select the item END OF COOKING with key  (8).



When the message SET TIME appears, use the keys   (3) to set the END OF COOKING time, within the next 23 hours 59 minutes.

Confirm the setting with the key  (8).



The oven will go into delayed start mode. It will be automatically activated later for a set duration and will stop at the programmed end of cooking time.

A clear message: “OVEN TO BE TURNED ON IN ...”

at 15 sec. intervals will be displayed to show the time remaining before the oven is turned on.

It is possible, however, to recall the information on the display at any time by pressing one of the two keys   (3)

## HOW TO CANCEL AN OVEN START/STOP PROGRAM

Press the keys   (3) simultaneously to cancel the oven start/stop program.



The oven will automatically activate and display the message: **COOKING IN PROGRESS**  
**↓ MENU**

## COOKING FINISHED MODE

The oven turns off all the heating elements.

The display shows the message: “**COOKING FINISHED**” accompanied by a buzzer signal.

The buzzer signal can be turned off by pressing any key.

Press the key  to turn off the oven or press one of the two keys   (7) to select a new cooking cycle.

N.B. In steam cooking cycles, two minutes before the cooking time ends the steam discharge vent opens in order to discharge as much steam as possible from the cooking chamber.

## COOKING WITH THE FOOD PROBE

The oven is supplied with an accessory shaped like a large pin inserted in a grip that ends with a cable and a plug. The food probe connected to the electronics allows to measure the temperature inside the meat or other food that is being cooked. This accessory simplifies the approach to the various cooking cycles for those with little experience in the sector, obtaining consistent results over time. **The cooking finishes when the temperature inside the food, measured by the probe, reaches the value set on the display.**

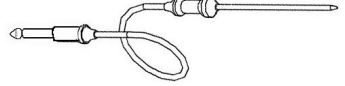

### How to use the food probe.

Connect the food probe on the appropriate connector located inside the oven, on top of the left wall (see fig. A). Insert the metal pin of the probe horizontally into the food to be cooked, up to the handle. The point, if possible, must be placed in the centre of the food and must not touch a bone or be inserted in any fatty parts of the food. A correct measurement can be obtained only by following these instructions.

Turn on the oven, select a cooking function, set the food probe temperature and set the cooking chamber temperature.

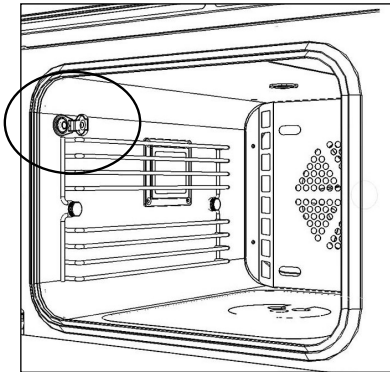

Fig. A

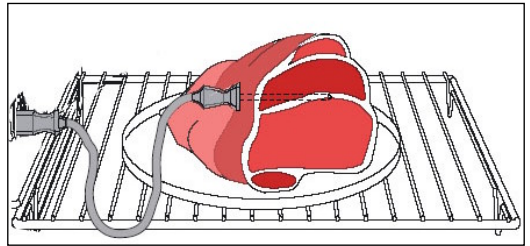



Fig. B

## HOW TO CHANGE THE FOOD PROBE TEMPERATURE

Press one of the two keys   (2) to change, with steps of +/-1°C, the food probe temperature.

Maximum temperature that can be set: 90°C

Minimum temperature that can be set: 30°C



The food probe temperature value is displayed with the following graphic symbol to the left:



### Notes:

- The chamber temperature must be higher than the food probe temperature. Otherwise, the display of the chamber temperature will flash to indicate an incorrect setting.
- It is not possible to set a cooking time using the food probe or vice versa.



## USING THE FOOD PROBE AS A THERMOMETER



Press the two keys   (2) simultaneously and the probe temperature display will show the instantaneous value measured by the probe.

The maximum and minimum temperature that can be measured is 250°C - 20°C.

## HOW TO PROGRAM THE START OF THE OVEN USING THE FOOD PROBE

Connect the food probe to the appropriate connector (see fig. A, page 20). Turn on the oven, select a cooking function and set the desired cooking temperature.

Then press the key:  (9) and select the item **START COOKING** with key  (8).

When the message **SET TIME** appears, use the keys   (3) to set the **START COOKING** time, within the next 23 hours 59 minutes.

Confirm the setting with the key  (8).

The oven will go into delayed start mode. It will activate automatically at the programmed time and stop at the end of cooking, i.e., when the food temperature reaches the value set for the probe temperature.

A clear message: **“OVEN TO BE TURNED ON IN ...”**

at 15 sec. intervals will be displayed to show the time remaining before the oven is turned on.

It is possible, however, to recall the information on the display at any time by pressing one of the

two keys   (3)

## SAVING A COOKING CYCLE

The oven electronics offers the possibility to store your cooking settings in appropriate memory areas. This information may be retrieved at a later time in order to cook with the same previous settings, obtaining consistent and unflinching results.

The following can be stored in the memory:

- **cooking cycle**
- **cooking chamber temperature**
- **food probe temperature** or alternatively **cooking time**

It is not possible to store:

- Start cooking time
- End of cooking time



## HOW TO SAVE A COOKING CYCLE

After turning on the oven and carrying out all the necessary cooking settings press key



(9) repeatedly until the following text appears: **SAVE COOKING CYCLE**

Press key:  (8) to confirm that you would like to save the data.

Select one of the 10 available records using the scrolling keys:  (9) or 

Confirm the saving of the data in **COOKING CYCLE NO.** with key  (8)

When the data has been saved, the system responds with "DONE"

### Notes:

- It is advisable to write down the number of the cooking cycle along with the name of the dish for which it is used in a notebook. This will help in the future when you would like to call up the cooking cycle to be used for this particular dish.
- If the system does not display the writing "DONE", this means that all the available memory records have been used. To save another cooking cycle, you must delete one or more records. See section [how to delete your own recipe](#) page 29

### Menu functions

- Recipes
- Settings
- Exit

**Recipes** : The system has a stored list of dishes (meat, bread/pizza, desserts, timbales, your own recipes) that allows a quick setting of the oven (recommended parameters) based on the item selected in order to obtain the correct cooking.

The following pages provide the tables and parameters of the food stored in the memory.

**Settings**: In this menu it is possible to carry out a series of settings that allow to personalize the oven based on your own needs.

See the list on page 32







## HOW TO ADD STEAM IN THE HOT AIR + STEAM COOKING MODE

The hot air + steam cooking cycle allows the user to add steam at any time during the cooking. In this manner the right degree of humidity inside the cooking chamber is reached or maintained in order to obtain a more tender dish.

Once the cycle has been selected and activated, the following message appears at regular intervals:

**PRESS  TO ADD STEAM**

Pressing the key  (8) turns on the symbol:  that indicates activation of the steam generator. After a few moments, steam will begin to flow into the cooking chamber. The steam is introduced into the chamber at constant intervals separated by brief pauses for a maximum period of about 15 min. at the end of which the steam generator and the indicator  turn off.

The introduction of the steam can also be deactivated manually at any time with key  (8).

The message shown on the display **PRESS  TO STOP STEAM** preceded by a beep signal reminds the user of this possibility.

## HOW TO MOVE AROUND INSIDE THE MENU

Turn on the oven. When the following message is displayed:

← → SELECT COOKING    ↓ MENU

press the key:  (9) to display the first item in the list: "RECIPES"



To view the menu structure:

press the key:  (9) to scroll down the list

press the key:  (9) to scroll up the list

Press the key:  (8) to select the item shown

EXIT allows to return at any time to the initial item displayed when the oven was turned on.

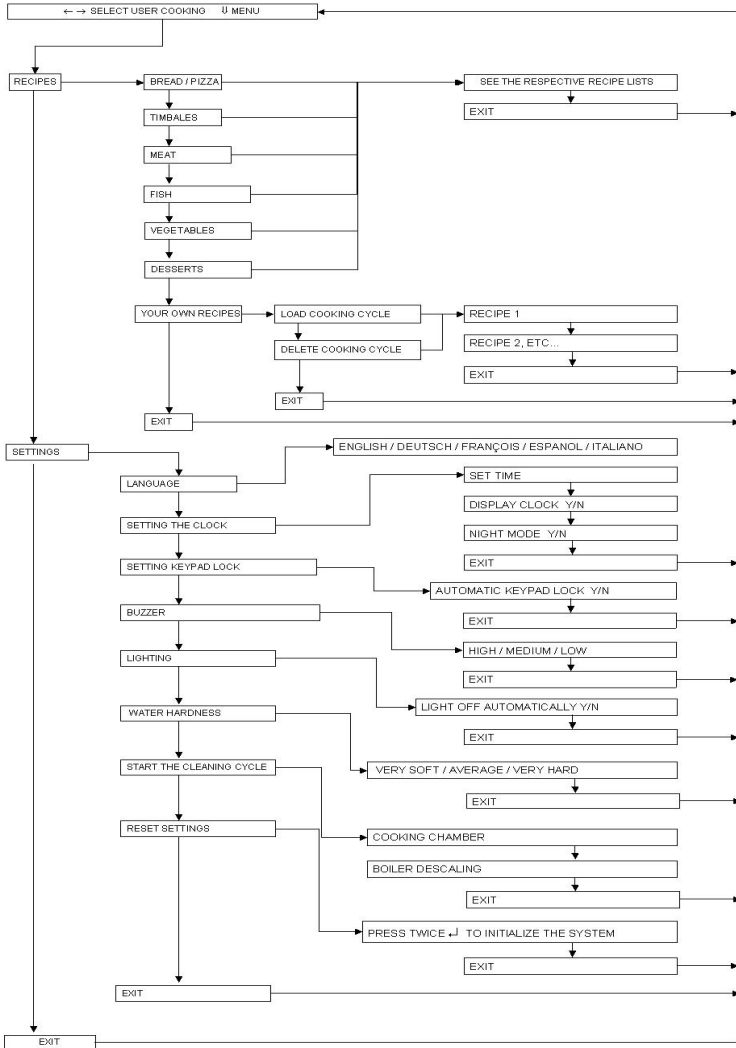

Pressing the keys   simultaneously allows to go back to the previous item one step at a time. (go back function <<< )

# MENU STRUCTURE FLOW-CHART





**BREAD/PIZZA recipe list**

Dish:	Cooking chamber temperature °C	Food probe temperature * °C	Cooking time	Level	Cooking cycle
SAVOURY FOCACCIA BREAD	220		00 <sup>h</sup> .25 <sup>'</sup>	3	
BREAD	220		00 <sup>h</sup> .35 <sup>'</sup>	3	
PIZZA	230		00 <sup>h</sup> .25 <sup>'</sup>	3	



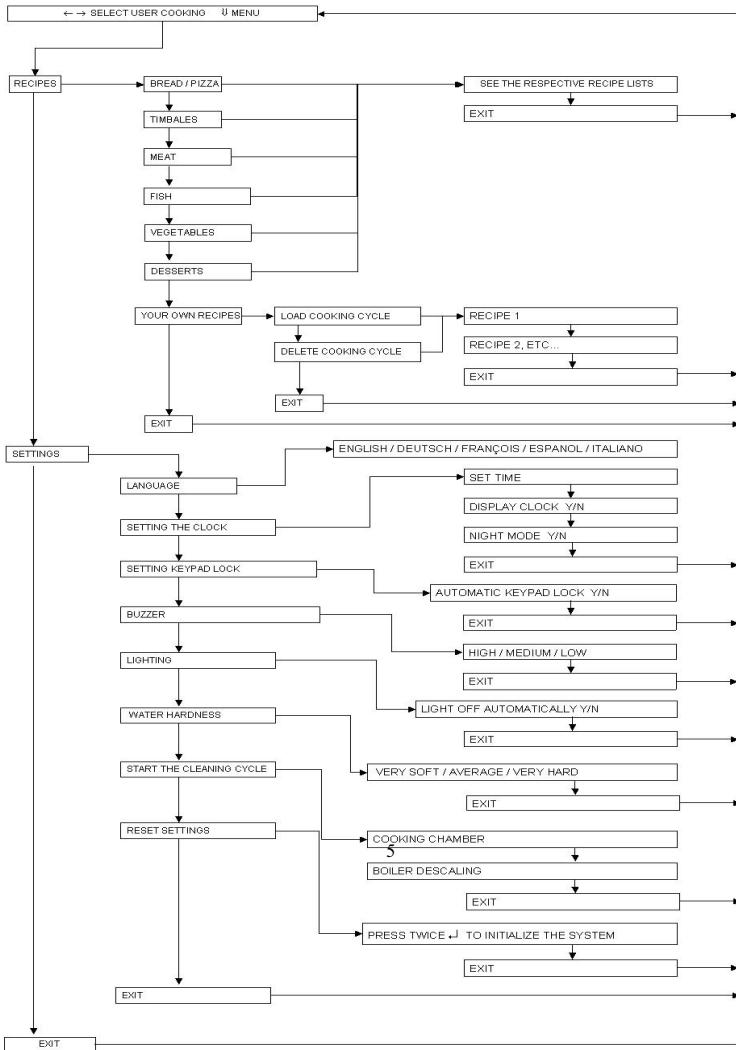

**TIMBALES recipe list**

Dish:	Cooking chamber temperature °C	Food probe temperature * °C	Cooking time	Level	Cooking cycle
CANNELLONI	190		01 <sup>h</sup> .00 <sup>'</sup>	3	
LASAGNE	180		01 <sup>h</sup> .20 <sup>'</sup>	3	
ASPARAGUS TIMBALE	180		01 <sup>h</sup> .10 <sup>'</sup>	3	
POTATO TIMBALE	180		01 <sup>h</sup> .20 <sup>'</sup>	3	
COURGETTE TIMBALE	180		00 <sup>h</sup> .40 <sup>'</sup>	3	
SAVOURY TART	200		00 <sup>h</sup> .35 <sup>'</sup>	3	

# MENU STRUCTURE FLOW-CHART



***FISH recipe list***

Dish:	Cooking chamber temperature °C	Food probe temperature * °C	Cooking time	Level	Cooking cycle
MUSSELS AND CLAMS	100		00 <sup>h</sup> .30'	3	
PLAICE FILLET	220		00 <sup>h</sup> .10'	3	
SCORPION FISH FILLET	80		00 <sup>h</sup> .30'	3	
PRAWNS AND FLAT LOBSTER	100		00 <sup>h</sup> .30'	3	
TROUT	100		00 <sup>h</sup> .35'	3	

***VEGETABLES recipe list***

Dish:	Cooking chamber temperature °C	Food probe temperature * °C	Cooking time	Level	Cooking cycle
ASPARAGUS	100		00 <sup>h</sup> .35'	3	
BROCCOLI	100		00 <sup>h</sup> .30'	3	
CARROTS	100		00 <sup>h</sup> .35'	3	
BRUSSELS SPROUTS	100		00 <sup>h</sup> .35'	3	
CAULIFLOWER	100		00 <sup>h</sup> .40'	3	
SWISS CHARD STALKS	100		00 <sup>h</sup> .35'	3	
GREEN BEANS	100		00 <sup>h</sup> .40'	3	
FENNEL	100		00 <sup>h</sup> .40'	3	
POTATOES	100		00 <sup>h</sup> .50'	3	
PEPPERS	100		00 <sup>h</sup> .25'	3	
LEEKS	100		00 <sup>h</sup> .40'	3	
RICE	100		00 <sup>h</sup> .35'	3	
CELERY	100		00 <sup>h</sup> .35'	3	
SPINACH	100		00 <sup>h</sup> .20'	3	
ZUCCHINI	100		00 <sup>h</sup> .30'	3	

The cooking times have been determined for average sized dishes. Cooking times may vary depending on the size of the dish.

**DESSERTS recipe list**

Dish:	Cooking chamber temperature °C	Food probe temperature * °C	Cooking time	Level	Cooking cycle
BISCUITS	150		00 <sup>h</sup> .35'	3	
YOGURT BISCUITS	170		00 <sup>h</sup> .15'	3	
PLUM CAKE	170		01 <sup>h</sup> .00'	3	
SOUFFLES	200		00 <sup>h</sup> .35'	3	
APPLE PIE	170		01 <sup>h</sup> .00'	3	
SPONGE CAKE	170		00 <sup>h</sup> .40'	3	

**NOTE:**

The settings listed in the tables (temperature, cooking time) may be changed to create personalized cooking better suited to your needs. New data can be entered to overwrite the data stored in the memory by following the instructions provided below.

**HOW TO PERSONALIZE THE RECIPE LIST**



Select an item from the list and set the data according to your own needs. Remember that it is possible to cook by time (cooking time) or with the food probe.

Activate the cooking, then press the key  (9) repeatedly until the following text appears: **SAVE COOKING CYCLE**

Press key:  (8) to confirm and store the new settings. The system displays **DONE** when the saving is finished.



**HOW TO LOAD YOUR OWN RECIPE**

Select menu and select the recipes item, with key  (8).

Scroll the items with key  (9) or key  (9) until the text **YOUR OWN RECIPES** is displayed.

Confirm the selection with key  (8)

When the following message appears: **LOAD COOKING CYCLE** press key  (8)  
The system displays the recipes that have been stored.



Use the key  (9) or  (9) to select the desired cooking cycle.

Confirm the selection by pressing key  (8).



N.B. If the memory area is empty because no personalized recipes have been stored, the system responds with **EXIT**.

**HOW TO DELETE YOUR OWN RECIPE**

Select menu and select the recipes item, with key  (8).



Scroll the items with key  (9) or key  (9) until the text YOUR OWN RECIPES is displayed.

Confirm the selection with key  (8)

Use one of the two keys   (9) to scroll the items until the following text is displayed:  
DELETE COOKING CYCLE.

Press key  (8) to enter the submenu.

Select the cooking cycle that you would like to delete, scrolling the items with one of the two keys

  (9), and confirm the deletion with the key  (8).

When the cooking cycle has been deleted, the system responds with **DONE**

## PRACTICAL COOKING SUGGESTIONS

- All cooking must be carried out with the door closed.
  - Always use completely dry oven gloves or pot holders to remove the hot dishes from the oven.
- Use containers able to withstand maximum temperatures of 250°C or higher.
- During or at the end of the cooking phase, be careful of the hot air that escapes from the oven when the door is opened.
- Never rest the dishes directly in contact with the bottom of the oven. Use the appropriate accessories.

## ACCESSORIES

The accessories supplied with the oven increase the number of cooking modes and possibilities. The drip pan and grill accessories can be placed on various levels of the slide guide located inside the oven. This allows the user to set the most suitable height (levels) depending on the cooking to be carried out. See the recipe list on page 26

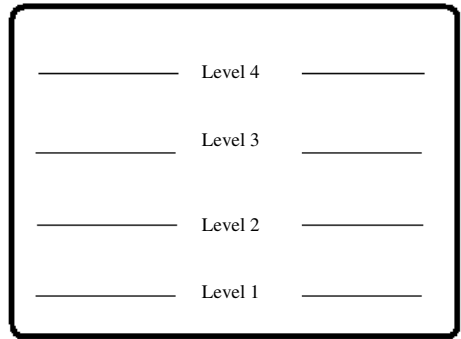

### *Drip pan*

Tray with raised edges used as a support surface for any single level or bain-marie cooking container.

Container for collecting juices or drippings of fat during the cooking process, used together with the main grill or the perforated drip pan. When cooking fatty dishes, it is recommended to place a bit of water in the drip pan to prevent the fat from burning and producing unpleasant odours or smoke.

Support surface for the food (biscuits, etc.)



### *Grill*

Used mainly as a support surface.

Recommended position: level 2 / 3 / 4

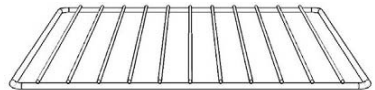

### *Perforated drip pan*

Used mainly for steam cooking (fresh or frozen vegetables, fish).

Position the perforated drip pan on level 2 or 3 and immediately insert the drip pan to collect the liquid released from the food.

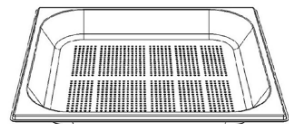

## *FOOD probe*

See section [COOKING WITH THE FOOD PROBE](#) page 20

N.B.



If the food probe temperature display is flashing with the value of 30°C, this means that the dish selected from those listed in the recipe list lacks an ideal probe temperature value. In this case, it is recommended to disconnect the food probe and cook according to the set mode or set a food probe temperature best suited to your expectations.

### HOW TO PERSONALIZE YOUR OVEN



Turn on the oven. When the following message is displayed:

← → SELECT COOKING ↓ MENU

press the key:  (9) to display the first item in the list: “RECIPES”.

Press the key  (9) and confirm the selection “SETTINGS” with key  (8)

Move around inside the SETTINGS submenu using the procedures described in section [how to move around inside the menu](#) on page 24.

To change the type of setting, press one of the two keys   (4).

The new setting must, of course, be confirmed with the “enter” key  (8).



The message “**DONE**” is displayed as confirmation of the new selection.

Use the MENU STRUCTURE diagram to help you become familiar with the items.

**LANGUAGE:** allows to set the display of the messages in the language best suited to the user.

Menu languages:

- ENGLISH,
- ITALIAN,
- GERMAN,
- FRENCH,
- SPANISH

Use the keys   (4). to scroll the list items and key  (8) to confirm the desired language.

### SETTING THE CLOCK

Move around in this submenu and select the item to be personalized using the procedures already described. See section how to move around inside the menu [how to move around inside the menu](#) on page 24.

The variable parameters are displayed in flashing mode and can be changed using the keys

  (4).

- **SET TIME**

Allows to set the current time.

Keep one of the two keys mentioned previously pressed down to scroll faster.

- **CLOCK DISPLAYED**

If NO is selected, the current time is not displayed when the oven is off.

- **NIGHT MODE**

Default setting = NO

If the setting is changed to YES, when the oven is off, during the time between 22.00 and 06.59.59 the clock digits are displayed with a low light intensity. During the remaining daytime hours, the maximum intensity returns to ensure proper display in case of reflection.



### **SETTING KEYPAD LOCK:**

This option allows to select the mode in which the keypad lock is set: manual or automatic. It is recommended to select the automatic mode (YES), especially if there are children present.

AUTOMATIC KEYPAD LOCK YES

The keys are locked automatically when the keypad remains inactive for 1 minute.

AUTOMATIC KEYPAD LOCK NO



The keypad lock is activated by simultaneously pressing the key on the far left  and the key on the far right .

In both cases, when the keypad lock is activated the display shows the message: KEYPAD LOCK ACTIVATED followed, if the oven is off, by the key symbol  to remind the user that the function is activated.

If the keypad lock is activated manually or automatically during a cooking process, the display, after the message: “KEYPAD LOCK ACTIVATED”, returns to displaying the cooking information. If someone attempts to perform new settings, the system responds to pressure on any key with a message that reminds the user to deactivate the protection first. See the next section.

### **HOW TO DEACTIVATE THE KEYPAD LOCK**

If the key symbol  is shown on the display, or the following message appears:  
↓ UNLOCK KEYS ↓ (The two arrows on the sides pointing downwards remind the user of the key combination)

Press simultaneously the key on the far left  and the key on the far right   
The message : KEYPAD LOCK DEACTIVATED confirms that the appliance's normal control functions have been restored.



## KEYPAD LOCK DETAILS

The key  allows to turn on / off the light in the cooking chamber regardless of the oven state.

The key  allows to turn the oven off.

## BUZZER

Allows to select one of the 3 levels (low, medium, high) for the intensity of the buzzer that sounds during a warning. Default setting: MEDIUM

## LIGHTING

Allows to select the criteria for turning off the light once it has been turned on.

Select NO for the item: LIGHT OFF AUTOMATICALLY to use the manual mode. Once the light has been turned on, it must always be turned off by pressing the appropriate key  again.

The automatic function (YES) allows the electronics to turn the light off automatically 5 minutes after it was turned on.

## WATER HARDNESS

The water hardness basically expresses the quantity of magnesium and calcium salts present in the water. The hardness is generally expressed in French degrees (°fH).

The oven is equipped with an automatic system that determines the appropriate moment to perform a boiler descaling cycle.



*Remember that it is advisable to use distilled water in order to reduce the formation of scale. There are three adjustment ranges for the water hardness.*

French degrees (°fH) / German degrees (°dH) equivalence table

WATER HARDNESS °fH		WATER HARDNESS °dH	
16-35° fH	AVERAGE WATER	0-8° dH	AVERAGE WATER
0-15° fH	VERY SOFT WATER	9-20° dH	VERY SOFT WATER
36-50° fH	VERY HARD WATER	21-28° dH	VERY HARD WATER

The default system is positioned on the average value (line 1 in the table).

To change the setting, see page 32, select water hardness, press the confirmation key  (8).

To enter into the option and then use one of the two keys   (4).

Once the selection has been made, confirm with key  (8).

See also the section: BOILER DESCALING on page 35

## START CLEANING CYCLE

Menu items:  
COOKING CHAMBER  
BOILER DESCALING

### COOKING CHAMBER

The purpose is to facilitate the removal of any residue of food, grease, etc. after a cooking process. The oven fills the cooking chamber with a certain quantity of steam for a fixed period of time (10 min.).

Activate the cooking chamber cleaning cycle with key  (8) and follow the instructions provided on the display.

When the cycle is finished and the following message appears:

**COOKING CHAMBER CLEANING CYCLE COMPLETE USE A CLOTH TO REMOVE DIRT**

use a soft cloth or non-abrasive sponge dampened with water to clean the oven. Do not use corrosive substances or liquids, do not use iron or pointed utensils.

### BOILER DESCALING

This is a particular cleaning cycle suitable for removing the scale inside the boiler.

Depending on the water hardness, a certain quantity of scale forms inside the boiler or steam generator that increases with the hardness of the water. See the section **WATER HARDNESS** on page 34

It is recommended that the descaling be performed as soon as the following warning message is displayed: **DESCALING CYCLE RECOMMENDED FOR BOILER**

**CAUTION:** THE CYCLE HAS A FIXED DURATION OF 12 HOURS. THUS, IT IS ADVISABLE TO PERFORM THE CYCLE DURING THE NIGHT

#### **Suitable descaler:**

It is recommended that CITRIC ACID MONOHYDRATE be used, which can be found at any ordinary pharmacy.

Follow the safety and dosing instructions. Do not use vinegar or vinegar-based products.

### INSTRUCTIONS for boiler descaling process:

**Dosing:** fill the pitcher with water up to the 0.6 L mark , add 5 teaspoons of citric acid monohydrate and dissolve.

Insert the pitcher in the appropriate seat and start the descaling process with key  (8).

The appliance will display the time remaining until the end of the descaling process.

When finished, a boiler wash and rinsing process will be carried out. See the section Boiler wash

### Boiler wash

When finished, the system performs a boiler wash cycle and empties the dirty water into the pitcher. It will then be necessary to assist the appliance which will guide you step by step through the operations to be carried out.

In summary, the necessary operations will be to empty the contents of the pitcher, rinse and fill the pitcher with clean water. This operation will have to be repeated several times.

Water may drip from the filter container. Dry and clean with a cloth or small sponge.

Pay attention to the white gaskets; make sure that they are present on the inner part of the filter container, otherwise position them correctly as shown below.

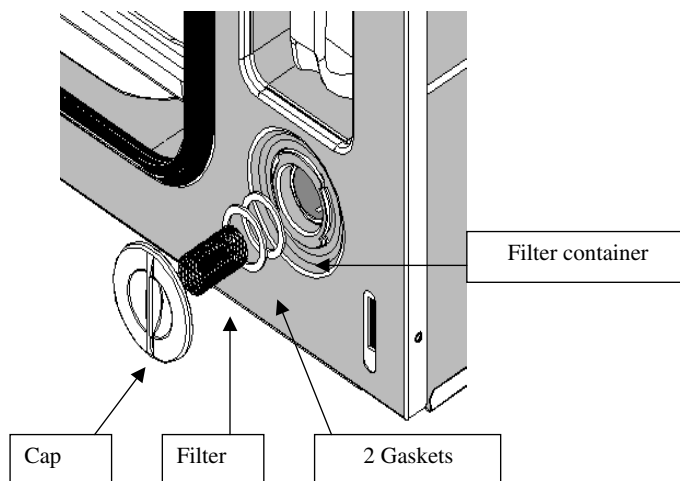

## **RESET SETTINGS**

This function is used to reset the system in case of problems.

Caution: All the system variables are returned to the original values and your own recipe are deleted.

Select the item : “ **RESET SETTINGS**” with key  (8) and follow the instructions provided on the display.

## OVEN OFF MODE

All the heating elements are deactivated, including the fan inside the cooking chamber and the light. The cooling fan and the fan located inside the cooking chamber deactivate a few minutes after the oven is turned off in order to allow rapid cooling of the oven. (Maximum cooling time: 20 min.)

The keypad is deactivated except for the on/off key  and the ALARM function keys. (see page 17 )

## COOKING FINISHED MODE

The control unit sounds a buzzer and deactivates all the heating elements, including the fan inside the cooking chamber and the light.

The display shows the message: **COOKING FINISHED**

- Press any key to stop the buzzer, cancel the message and return the system to the ON conditions.
- Or press the On/Off key to turn the oven off. (see oven off mode)
- Otherwise the oven will turn off automatically after 5 minutes.

## WHAT TO DO IN CASE OF AN ANOMALY

<b>PROBLEM</b>	<b>SOLUTION</b>
The oven does not work.	Check whether the omnipolar switch or any residual-current circuit breaker (cut-out) of the electrical system is off. In case of problems with the electrical system, consult a qualified electrician. If the oven still does not work after resetting the omnipolar switch and/or residual-current circuit breaker, contact an Authorized Service Centre.
The light inside the cooking chamber does not turn on.	See the instructions on how to change the oven light bulb on page 42
The display shows Err and a number.	This combination indicates a failure. See the error codes table on page 40
The system requires the time to be set.	Probable electricity failure (Black-out). Set the current time. See page 14 or page 32
The draining of the water from the boiler occurs a long time after the end of a cooking process.	For safety reasons the water from the boiler is pumped away only when the temperature has dropped below 90°C. The time necessary for the water to cool determines the pause before the draining starts. (this may last up to 20 min.) During this time, another cooking process can be started.
Steam comes out of the oven during operation.	Check whether the door is closed correctly. Check whether the seal is damaged with cracks, etc. In the second case, contact an Authorized Service Centre.
The system displays a food probe temperature during operation without the food probe connected.	Check the seal of the food probe connector cap inside the cooking chamber. If the cap is unstable, it must be replaced. Contact an Authorized Service Centre.

## WHAT TO DO IN CASE OF A BLACK-OUT

- In the case of a black-out, when the electricity is restored it may be necessary to reset the current time.
- The stored settings or recipes are not lost.
- If the black-out occurs during a cooking process, the process cannot continue.
- If a descaling or boiler cleaning process was in progress before the blackout, the process is aborted. When the electricity is restored, it will be necessary to drain the solution of water and citric acid monohydrate contained in the boiler. Follow the instructions shown on the display of the appliance. See the section [Boiler wash](#) page 36

## ERROR CODES TABLE

The electronic system continually performs a series of diagnostic tests. If some parameters are incorrect, the control unit deactivates the functions and displays an error code (Err followed by three numerical digits); all the heating elements are turned off, including the fan inside the cooking chamber. The cooling fan remains on.

Take note of the error code and contact an Authorized Service Centre, specifying the error code.

Error Code	Cause	SOLUTION
Err 001	BOILER overheat The causes of this alarm are: The fill pump does not pour the water from the pitcher to the boiler. The causes may be: a – empty pitcher b – a leak in the hydraulic circuit c – broken pump d – electronic failure in the power circuit (relay or relay control)	Check that there is water in the pitcher. Turn the oven off and on again. If the failure repeats, take note of the error code and contact an Authorized Service Centre, specifying the error code.
Err 002	Boiler protection alarm. The system de-energizes the GEN. relay in advance, and thus all the loads connected to it. - Replace the power card	Take note of the error code and contact an Authorized Service Centre, specifying the code.
Err 003	Power card overheat: threshold value $\geq 85^{\circ}$	Check whether the oven is embedded in the furniture according to the instructions in this handbook.  Check whether the tangential fan is operating correctly.
Err 004	PT1000 cooking chamber sensor Cause: interruption or short circuit of the sensor or cables. - Replace the PT1000	Contact an Authorized Service Centre, specifying the code.
Err 005	Food sensor Cause: interruption or short circuit of the sensor or cables. - Check the electrical connections. - Replace the food probe.	Contact an Authorized Service Centre, specifying the code.
Err 006	Boiler thermocouple failure Cause: open circuit or short to earth. - Replace the BOILER.	Contact an Authorized Service Centre, specifying the code.
Err 007	Cooking chamber steam presence thermocouple failure Cause: open circuit or short to earth. - Replace the TC1.	Contact an Authorized Service Centre, specifying the code.
Err 008	Cooking chamber overheat - Replace the power card	Contact an Authorized Service Centre, specifying the code.
Err 009	Failure of the ntc sensor on the power card Cause: open circuit or short. - Replace the power card	Contact an Authorized Service Centre, specifying the code.

## HOW TO DISASSEMBLE THE SIDE GRILLS

1. Unscrew (turning anti-clockwise) the front knurled nuts (D).
2. Extract, one at a time, the side grills (G).

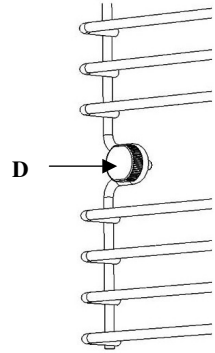
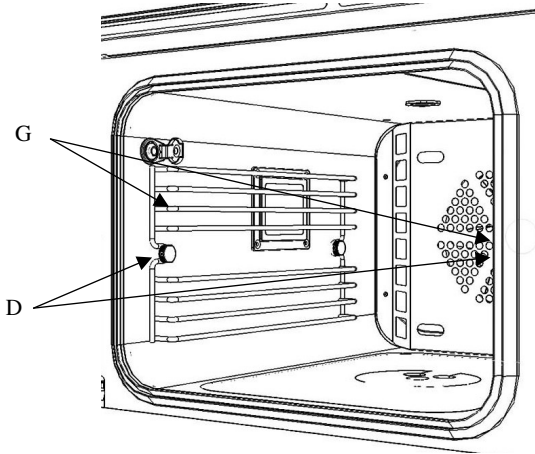

## HOW TO REASSEMBLE THE SIDE GRILLS

Insert the support grills one at a time. (G)

Pay attention to the index on the grill. This must be inserted on the rear knurled nut inside the cooking chamber.

Screw on the knurled nuts (D).



## HOW TO CHANGE THE OVEN LIGHT BULB

Disconnect the appliance from the power supply or place the omnipolar switch in the OFF position. Check that the oven is at room temperature, otherwise wait for it to cool.

The oven light bulb must have the following characteristics:

- Supply voltage 220-240 V (50/60 Hz)
- power 25 W.
- Base type: E-14
- Maximum operating temperature 300°C

### *Instruction for changing the light bulb:*

1. Unscrew the knurled nut of the leftside support grill, see the previous page.
2. Extract the support grill.
3. Unscrew the 4 cross screws located on the corners of the glass support (see drawing to the side).
4. Place the frame, with glass and seal to protect the lamp, on a support surface.

Rubber seal

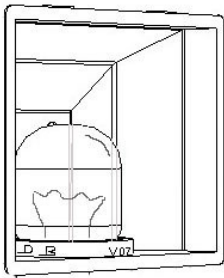
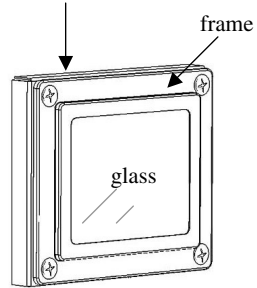

5. Unscrew the burnt-out bulb.
6. Insert and screw in the new light bulb.
7. Reassemble the frame assembly with glass and seal.
8. Screw in the 4 screws.
9. Reassemble the side grill.
10. Screw on the knurled nut of the side grill.
11. Reconnect power.

## HOW TO CHANGE THE COOKING CHAMBER SEAL

The seal located around the cooking chamber must be replaced if it has any cracks.

For safety reasons, the seal must be changed by an Authorized Service Centre technician.

## HOW TO DISASSEMBLE THE OVEN DOOR

1. Open the oven door completely.
2. Locate the hinges (C) , see the drawing to the side:

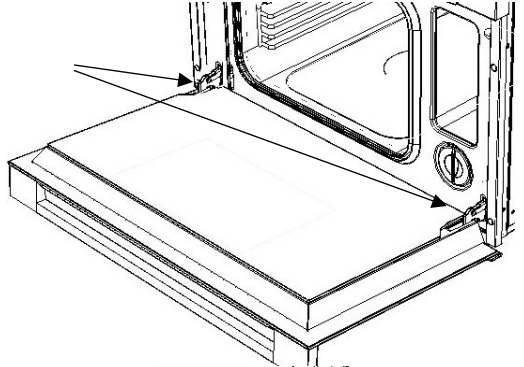

3. Tip back the brackets (A) on the two hinges (C).

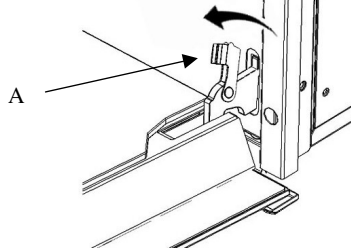

4. Grip the door on the two sides and close it slowly halfway, the brackets (A) will hook onto the door of the appliance.
5. Lift the door upwards.
6. Extract the door by rotating the lower part backwards. The brackets must come out of their seats. See the drawing below.

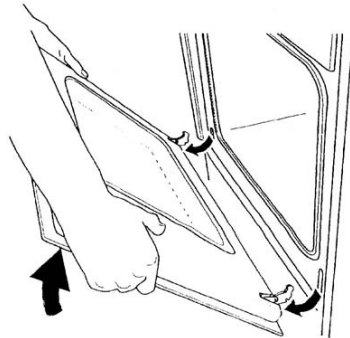

## HOW TO REASSEMBLE THE OVEN DOOR

1. Insert the two brackets into the appropriate openings, keeping the door semi-closed.
2. Open the door completely.
3. Tip over the two hinges (C) moving them forward.

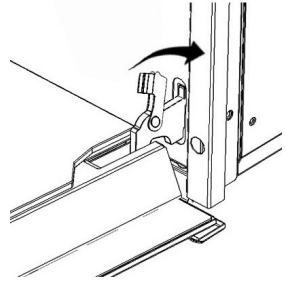

## OVEN DETAILS

### *Touch-Control Keypad*

This is a particular type of keypad which is touch-sensitive. To give a command to the oven, it is enough to indicate and apply light pressure on the point of the keypad where the symbol corresponding to the instruction is located.

### *Keypad command inactivity*

After 5 minutes without confirmation of a cooking cycle activation or without confirmation of an option, the oven turns off automatically.

### *'Beep' Signal*

A brief acoustic signal is emitted every time a key is pressed.

### *Cooling fan*

The oven is equipped with a cooling fan to ensure proper operation and reduce the temperature of the external surfaces of the oven.

The fan is always active during the cooking process, and it is possible to feel the jet of air that comes out between the front panel and the door of the oven.

### *Golden colour of the cooking chamber*

After a certain period of oven use, the cooking chamber takes on a golden colouring. This colouring of the stainless steel, due to natural causes, has no effect at all on the cooking characteristics.

## **SYSTEM WARNINGS:**

The meaning of some warning messages.

### **CHECK THAT THERE IS WATER IN THE PITCHER**

Generally 1L. of water in the pitcher is sufficient for a steam cooking process, nevertheless the message in question may be displayed for two reasons:

- The water in the pitcher has finished.
- The pitcher is not inserted completely in its seat.

Open the oven door in both cases, being careful of any steam that may come out.

- Add max. 1L. of distilled or drinking water, if necessary. (N.B. NEVER fill the pitcher completely, otherwise the water pumped by the steam generator back into the pitcher, at the end of the cooking cycle, may overflow from the container.)
- Insert the pitcher into its seat.
- Push the pitcher down completely to ensure a perfect seal between the tube located in the pitcher and the hydraulic circuit inside the oven.

### **INSERT THE PITCHER**

This message is displayed when the system must drain the water contained inside the boiler but the pitcher is not present in the appropriate seat.

### **CONNECT FOOD PROBE**

This message is displayed upon selection of the low temperature cooking cycle or a personalized recipe which requires use of the food probe, and only if the latter is not already connected on the appropriate connector.

### **DISCONNECT FOOD PROBE**

This message is displayed if the setting of the selected recipe does not require the food probe and only if the latter is connected.

### **CLOSE THE DOOR**

This message is displayed to indicate that the selected process or the process previously in progress can start only when the door is properly closed.

The door-open condition determines the interruption of a cooking process or steam controlled cycles.

### **BOILER EMPTYING**

**WAIT...**

## DISPOSAL

### Packaging

- The parts of the oven packaging (cardboard, EPS expanded polystyrene, PE plastic bags) should be disposed of in compliance with environmental regulations and using appropriate separated collection channels.

### Oven:

- Disconnect the oven from the outlet or, in case of fixed installations, contact an authorized electrician to request uninstallation.
- Before scrapping the appliance, make it unusable by cutting the power cord.

This appliance is marked in compliance with European Directive 2002/96/EC, Waste Electrical and Electronic Equipment (WEEE). By making sure that this product is properly disposed of, the user contributes to preventing potential environmental and health damage.



The symbol  on the product, or on the documentation that goes with it, indicates that this product must not be considered as domestic waste. It must instead be turned over to suitable collection centres for the recycling of electrical and electronic equipment.

Dispose of it in accordance with local standards for waste disposal.

For further information on the treatment, recovery and recycling of this product, contact the proper local authority, the domestic waste collection service or the retailer where the product was purchased.