

Eurolux

Dishwasher
DW9-CBE7
Instructions for Use

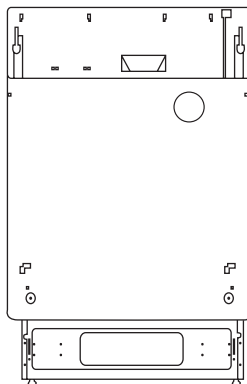

Code: 012050

Safety information	2
Installation	4
Getting to know your dishwasher	11
How to fill the salt	12
How to fill rinse aid	14
How to fill the detergent	15
Not suitable for the dishwasher	16
Arranging crockery, glasses, etc. in the dishwasher	17
Programme overview	19
Washing dishes	21
How to keep your dishwasher in shape	26
Care and maintenance	27
Fault finding	28
Technical data	32
Important information	32

At time of delivery

- Check packaging and dishwasher immediately for signs of transport damage. If the appliance is damaged, do not put it into use but contact your supplier or customer service without delay.
- Please dispose of packaging materials properly.

During installation

- Place the dishwasher and connect it up in accordance with the installation instructions.
- The dishwasher must not be connected to the electricity supply while installation is being carried out.
- Ensure that the domestic wiring is properly earthed.
- The mains electricity supply must conform to the details shown on the dishwasher nameplate.
- Do not connect the dishwasher to the electricity supply via an extension cable.
- Built-under and built-in appliances should always be installed under a continuous work surface which is attached to the adjacent cupboards, in order to ensure that the appliance is entirely stable.
- After the appliance has been installed, the mains plug should still be easily accessible.
- The plastic housing on the water inlet contains an electrically operated valve. The connecting wires are inside the inlet hose. Do not cut through this hose and do not immerse the plastic housing in water.
- During installation, the power supply cord must not be excessively or dangerously bent or flattened.
- For Switzerland only:

There are no restrictions on installing the appliance between wooden or plastic walls as part of a fitted kitchen. If the appliance is not plugged into a wall socket, it must be connected to the mains via a separator for all poles within the domestic wiring system. This device must have a gap of at least 3mm between open contacts, in order to conform with relevant safety regulations.

During normal use

- The dishwasher must only be used by adults for the washing of household dishes and cooking utensils.
- This appliance cannot be installed outdoor, not even if the area in which it is installed is covered by a roof; it is also very dangerous to leave it exposed to the rain and elements.
- Do not place any heavy objects or stand on the door when it is open. The appliance could tip forward.
- The water inside the dishwasher is not suitable for drinking.
- Do not use solvents of any kind inside your dishwasher. They could cause an explosion danger. Open the door very carefully if the dishwasher is operating. There is a risk of water squirting out.
- Do not touch the heating element during or after a wash cycle.
- Fundamental rules to follow when using the appliance:
 - Never touch the dishwasher when barefoot or with wet hands or feet;
 - We discourage the use of extension cords and multiple sockets;
 - If the appliance is not operating properly or maintenance must be performed, disconnect the appliance from the power supply.

If your family includes children

- This appliance is not intended for use by persons (including children) with reduced physical, sensory or mental capabilities, or lack of experience and knowledge, unless they have been given supervision or instruction concerning use of the appliance by a person responsible for their safety.
- Children should be supervised to ensure that they do not play with the appliance.
- Keep detergents out of the reach of children, who must also be kept away from the dishwasher when it is open.

If a fault occurs

- If the appliance malfunctions, turn off water supply to the appliance and disconnect the plug from the wall socket. Then, consult the section entitled, "Fault finding". If you cannot solve the problem, contact a service center.
- Only specialised personnel are authorised to make repairs.
- If the supply cord is damaged, it must be replaced by the manufacturer, its service agent or similarly qualified persons in order to avoid a hazard.
- To maintain the EFFICIENCY and SAFETY of this appliance, we recommend:
 - call only the Service Centers authorized by the manufacturer.
 - always use original Spare Parts.

When disposing of old appliances

- Appliances which are no longer being used must be made inoperable by cutting the power supply cord and removing the door lock.
- Take the appliance to a designated waste disposal center.



Dangerous voltage



Warning

Children could get locked in the appliance (risk of suffocation) or get stuck in other positions. Therefore: Remove the mains plug, cut the mains wire and set aside. Damage the door lock so that the door can no longer be closed.

Positioning the appliance

Change the appliance in the desired location. The back should rest against the wall behind it, and the sides, along the adjacent cabinets or wall. The dishwasher is equipped with water supply and drain hoses that can be positioned to the right or the left to facilitate proper installation.

Levelling the appliance

Once the appliance is positioned, adjust the feet (screwing them in or out) to adjust the dishwasher, making it level. In any case, the appliance should not be inclined more than 2°. If the appliance is levelled, it will help ensure proper performance.

Cold water connection

Connect the water supply hose to a threaded 3/4" (gas) connector, making sure that it is fastened tightly in place (see fig.A).

Some models are fitted with an "AquaStop" water supply hose (see fig.B) in which the small filter is already housed in the threaded end.

If the water pipes are new or have not been used for an extended period of time, let the water run to make sure that the water is clear and free of impurities. If this precaution is not taken, there is a risk that the water inlet can get blocked and damage the appliance.

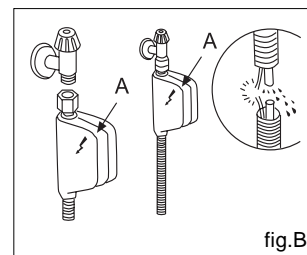
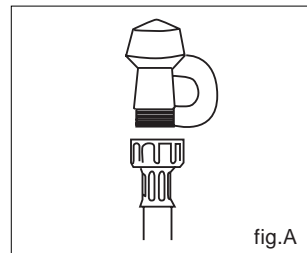

Warning

The appliance is to be connected to the water mains using new hose-sets and that old hose-sets should not be reused.

Anti-Flooding protection

If dishwasher is equipped with a system that stops the supply of water in the event of a problem with the water supply hose, or leaks within the unit, in order to prevent damage to your home. If for any reason the box containing the electrical components happens to get damaged, remove the plug for the appliance from the socket immediately. In order to guarantee that the anti-flooding feature operates properly, the "A" box with water supply hose must be attached to the water supply tap as shown in fig.B. No other type of connection is acceptable. The water supply hose must not, under any circumstances, be cut, as it contains electrical parts which are live. If the length of the hose is not adequate to make a proper connection, the hose must be replaced with one which is long enough. This hose is available upon request from specialised retailers and service center.

Drain hose connection

Insert the drain hose into a drain pipe with a minimum diameter of 4cm, or let it run into the sink, making sure to avoid bending or crimping it. If necessary, fit a syphon trap (U-bend) with a connecting piece for the drain hose (fig.C). The free end of the hose must be at a height between 40 and 100 cm and must not be immersed in water.

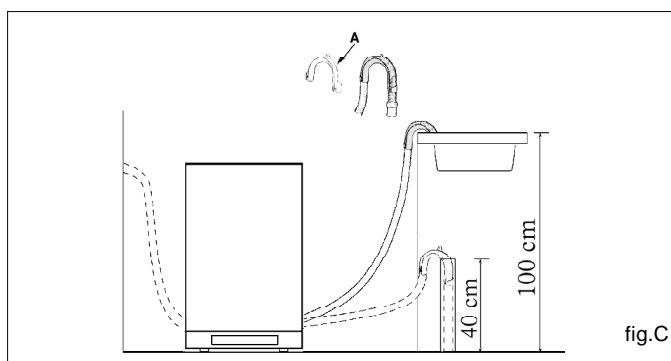

Attention:

The connecting piece for syphon trap (U-bend) must be solidly fastened to the wall to prevent the drain hose from moving and allowing water to spill outside the drain.

Electrical Connection

After making sure that the voltage and frequency values for the current in the home correspond to those on the rating plate (located on the stainless steel inner door of the appliance) and that the electrical system is correct for the maximum voltage on the rating plate, insert the plug into an electrical socket which is earthed properly (the earthing of the appliance is a safety requirement mandated by law). If the electrical socket to which the appliance must be connected is not appropriate for the plug, replace the whole cable, rather than using adaptors or the similar like as they could cause overheating and burns.



Caution:

The dishwasher plug must be accessible even when the appliance is installed as a built-in unit so that maintenance can be done safely.

Installation cont..

Stage 1

Supplied with the appliance is a plastic (self adhesive) anticondensation strip, this should be fixed to the underside of your worktop along the front edge. The adjustable feet of the appliance allow it to be raised up to 870mm, if the space between the floor and the underside of the work surface is greater than 870mm, then the appliance should be positioned on suitable

wooden spacers which should always be fixed to the floor. Always use a spirit level to make sure that the appliance is level left to right and front to back. (If the appliance is installed on a carpet, ensure there is clearance beneath the appliance). The four adjustable feet should be adjusted to the correct height; the rear feet are adjustable via studs at the front of the appliance (fig 1a).

To prevent damage to the floor covering, the appliance must be installed using the plastic skids provided.

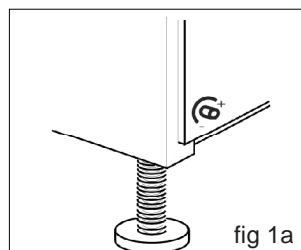

Stage 2

Connect the water, drain and electrical supplies (220V~240V, 50Hz). We recommend that the appliance is connected to a cold water supply.

Stage 3

Measure the width of the decor door. Align the template on the rear of the door with the top of the door level with the top of the template, and the left hand edge of the door in line with the measured door width. Mark the four fixing positions. Repeat on the right hand side. Remove the template, and drill pilot holes in the door in all eight positions using a suitable drill (take care not to drill through the door). Attach the upper plastic studs and lower fixing brackets to the decor door as shown below.



Stage 4

Position the decor door onto the front of the dishwasher by locating the brackets into the two plastic studs mounted either side on the top of the door. Lift the decor door until the lower brackets locate into the slots in the appliance door.

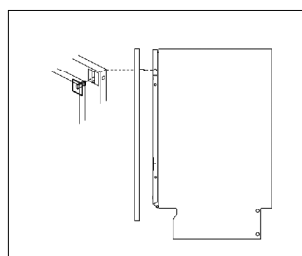

Stage 5

Align the top of the decor door with adjacent cabinets. Gently open door whilst supporting the decor door. Once in the lowered position, secure the decor door using the fixing screws provided as shown in the diagram. Cover the screw heads using the plastic caps provided.

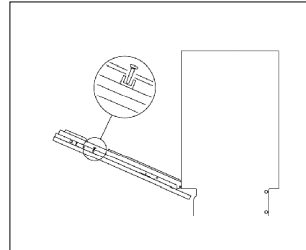

Stage 6

The dishwasher should now be screwed to the underside of the worktop, via the two fixing holes in the top trim.

For non-wooden worktops (e.g. marble) two brackets are provided to allow the appliance to be secured to the sides of the adjacent cabinets. The should be secured to the appliance using the two screws at the top of the chassis (see fig 1b), adjusted to the correct width and then screwed to the adjacent sides panels using suitable screws.

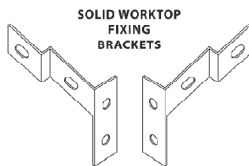

bracket
fixing
screws



bracket
fixing
screws

fig 1b

Stage 7

The door balance can be adusted via two screws accessed through two holes in the top of the front frame. Adjust these until the door just remains open under its own weight and is level when open.

Stage 8

Cut clearance in the plinth to allow the door to open fully and seal edges with a suitable varnish to prevent water ingress.

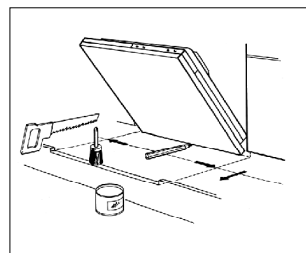

Assembly Instructions for Integrated Dishwasher

Mounting the Wooden Panel onto the Door and Sliding the Dishwasher into the Cabinet

During the preparatory stages for installing the dishwasher into the kitchen cabinet, holes must not be drilled in the sides, or door, in order to avoid compromising the performance and/or operation of the appliance. Before working on any internal components, the unit must be disconnected from the power supply. The maximum dimensions for the wood panel that can be installed on the door are: Height - 725 mm for the completely built-in version; Width - 448 mm; Thickness-20 mm.

The height dimension of 725 mm must be reduced if the height of the control panel is increased through the use of the spacers. In addition, the base must be trimmed if it interferes with the opening of the door.

Using the Drilling Template

Align the top edge of the template (identified with the "A" arrow) with the top edge of the panel. On both sides of the template (top and bottom) are written the various dimensions that correspond to the different possible widths for the panel. Align the template with the side of the panel (left or right), making sure that the panel coincides with the appropriate dimensions. Mark the positions for the holes for the screws, using the tip of a drill or a pencil. The three holes closest to the side should be used(B). Repeat this step on the other side of the panel ,using the corresponding side of the template.

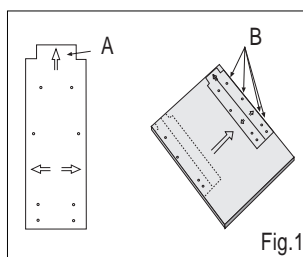

Fig.1

Fastening the Bracket to the Wooden Panel (Fig.2)

At the point marked, drill holes 2 mm in diameter. If the panel is made of chip board, only drill through the veneer. If the panel is made of solid wood, the holes can be made deeper. Position the two brackets so that they are lined up with the holes made in the bottom part of the panel. The holes furthest to the outside should be used to fasten the brackets. The small fins should be turned downward. The hooks should be screwed into the two holes at the top.

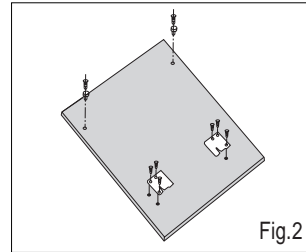

Fig.2

Mounting the Wood Door Panel onto the Dishwasher

Place the wood panel onto the door of the dishwasher. Then perform the installation steps described below,

Insert the top hooks into the appropriate slots in the dishwasher control panel. Then push the panel upwards until it stops. Afterwards, slide the panel downward again, moving the bottom of the panel toward the door so that the fins on the brackets slide into their slots (Fig.3).

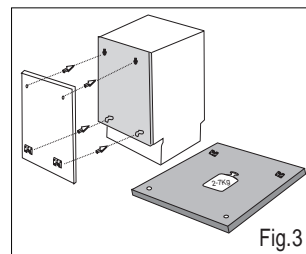

Fig.3

In both cases, open the doors of the dishwasher (the panel should stay in place by itself) and align the panel with the door, keeping it in contact with the control panel. Remove the small plastic plugs that cover the holes on the inside of the dishwasher door and fasten the panel in place with the screws provided (Fig. 4). Remember to cover the two holes with the plastic plugs removed earlier.

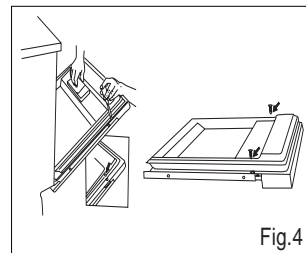

Fig.4

Adjusting the Door Springs (Fig.5B)

The door must be perfectly balanced. In the factory, the tension of the springs is regulated to ensure that the door is perfectly balanced when light wood door panels are mounted on the door. If heavier, solid wood door panels are used, the door can be balanced by simply turning the two screws (both screws must be turned the same amount) located on the top part of the machine.

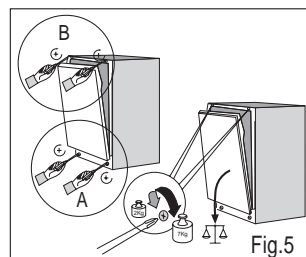

Fig.5

Installation of Continuous Base Moulding

Position the washing machine in the cut-out in the kitchen cabinet:

1. Install the continuous base moulding , following the manufacturer's instructions .
2. Slowly open the door of the dishwasher to check to see if the door strikes or rubs against the base moulding.
3. If so, rest the bottom edge of the panel on the base moulding and mark the part to be cut. Leave at least 3 mm of the play between the panel and the base moulding to allow for the door to rotate freely (Fig.6).
4. Remove the base moulding and trim it as needed, protecting the surface that has been cut with a paint or similar wood finish (Fig.11).
5. Install the base moulding again (Fig.7).

How to use water-proof plastic

Firstly take off the water-proof plastic from the sticker with the appliance (see Fig.8). Secondly stick it on the bottom of the kitchen board (see Fig.8). All of this can avoid humidity in the kitchen.

Positioning the Unit within the Cutout (Fig.9)

Push the dishwasher into the cutout opening and turn the feet to make it level and to adjust for height so that the crosspiece (A) for fastening it in place located on the top part of the machine (Fig.9) comes into contact with the counter. Align the door panel mounted on the dishwasher with the doors on the adjacent cabinet (2).

Important:

The dishwasher must absolutely be fastened to the counter top to prevent the machine from tipping when the loaded dish racks are pulled out.

Adjustment of Back Feet (Fig.5A)

Insert the appliance in the cutout and then adjust the height of the machine using the screws located at the bottom front. Use a screwdriver to turn the screws in a clockwise direction to raise the dishwasher and in an anticlockwise direction lower it.

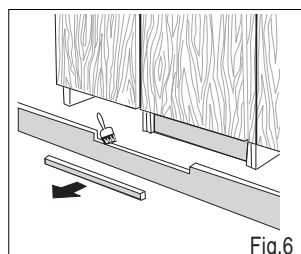

Fig.6

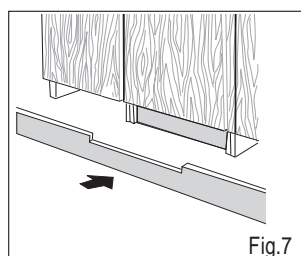

Fig.7

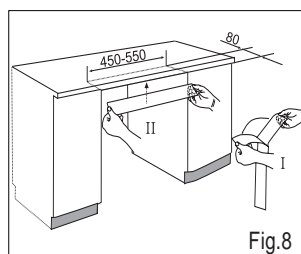

Fig.8

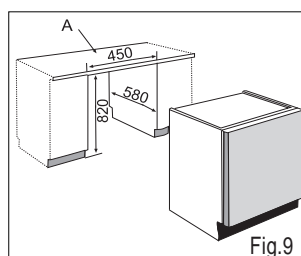

Fig.9



NOTICE:

If power screwdrivers are used to make the adjustment, make the final adjustment manually with a normal screwdriver.

Close-up view (control panel)

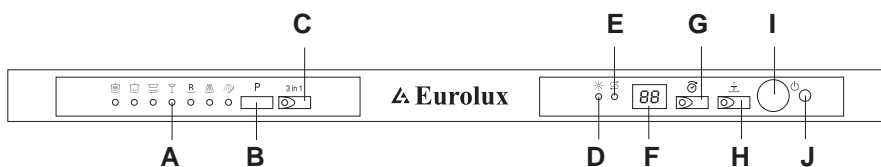

- | | |
|----------------------------------|-----------------------------------|
| A Programme Indicator | F Time-remaining Indicator |
| B Programme Button | G Delayed Start Button |
| C "3 in 1" Button | H " 1/2 " Button |
| D Low Rinse Aid Indicator | I ON-OFF Button |
| E Low Salt Indicator | J ON-OFF Indicator |

Dishwasher interior

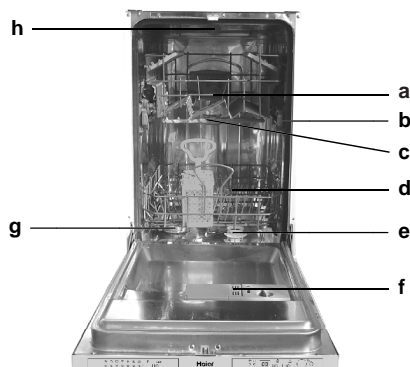

- | | |
|-------------------------------|--|
| a Upper Rack | e Washing Filter |
| b Rack Height Adjustor | f Detergent and Rinse Aid Dispenser |
| c Top Spray Arm | g Bottom Spray Arm |
| d Lower Rack | h Third Sprayer |

Salt

The hardness of the water varies from place to place. If hard water is used in the dishwasher, deposits will form on the dishes and utensils.

The appliance is equipped with a special softener that uses a salt specifically designed to eliminate lime and minerals from the water.

Loading the salt into the container

Always use salt intended for use with dishwashers.

The salt container is located beneath the lower rack and should be filled as follows:

- When the low salt indicator "E" lights, you must fill the salt.
- Remove the lower rack and then unscrew and remove the cap from the salt container;
- If you are filling the container for the first time, fill it with water;
- Place the end of the funnel (supplied) into the hole and introduce about 2 kg of salt. It is normal for a small amount of water to come out of the salt container.
- Carefully screw the cap back on.

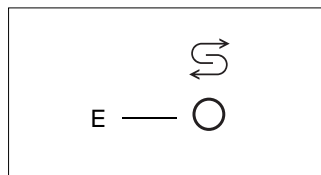

Important

To prevent the formation of rust, load the salt just before beginning a wash cycle.

Adjusting salt consumption

The dishwasher is designed to allow for adjusting the amount of salt consumed based on the hardness of the water used. This is intended to optimize and customize the level of salt consumption so that it remains at a minimum.

To adjust salt consumption, proceed as follows:

- Unscrew the cap from the salt container;
- There is a ring on the container with an arrow on it (see figure to the side),
- If necessary, rotate the ring in an anticlockwise direction from the "-" setting towards the "+" sign, based on the hardness of the water being used.

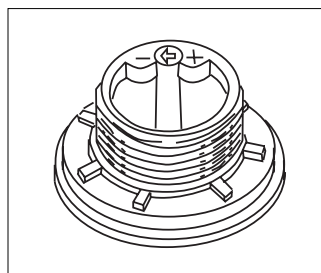

It is recommended that adjustments be made in accordance with the following table:

Water Hardness				Selector position	Salt consumption (Grams/cycle)	Autonomy (cycles/2kg)
Level	Clarke degrees	°dH	mmol/l			
1	0 - 14	0 - 17	0 - 1,7	/	0	/
2	14 - 36	18 - 44	1,8 - 4,4	"-"	20	60
3	36 - 71	45 - 89	4,5 - 8,9	middle	40	40
4	>71	>89	>8,9	"+"	60	25

Rinse aid

This product makes dishes sparkle and helps them to dry without spotting. The dispenser is located on the inside panel of the door .

When the low rinse aid indicator " D " lights , you must load rinse aid .

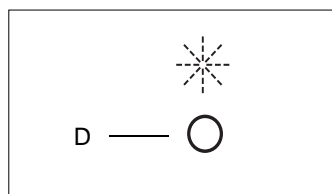

Loading the rinse aid

Regardless of the type of detergent dispenser installed on your appliance, you must proceed as indicated below when loading the rinse aid.

To open the dispenser, turn the "1" cap in an anti-clockwise direction and then pour in the rinse aid, making sure not to overfill. The amount of rinse aid used for each cycle can be regulated by turning the "2" dose adjuster, located beneath the "1" cap, with a screwdriver.

There are 6 different settings; the normal dosage setting is 3.

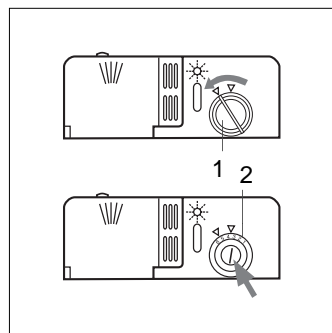

Important

Proper dosage of the rinse aid improves drying.

If drops of water remain on the dishes or spotting occurs, the dosage adjuster should be turned to a higher setting.

If the dishes have white streaks, turn the dosage adjuster to a lower setting.

Detergent

Detergent specifically intended for use with dishwashers must be used. The dispenser must be refilled before the start of each wash cycle following the instructions provided in the "Programme overview". The detergent dispenser is located on the inside panel of the door.

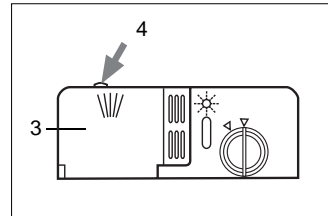

Loading the detergent

- To open the "3" cover on the dispenser, press the "4" button.
- The detergent for the wash cycle should be poured into the "5" compartment.
- The detergent for the pre-wash cycle should be poured into the "6" compartment.
- After the detergent has been placed in the dispenser, close the cover and press down until it clicks in place.

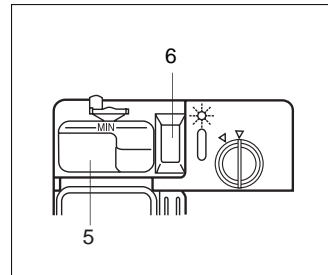

Notice:

To facilitate closing the cover, remove any excess of detergent on the edges of the dispenser.



Notice:

The usage of 3 in 1 or similar tablets is forbidden when Heat wash, Rapid Wash and Soak programmes are selected.

What you should not put into the dishwasher

Cutlery and tableware manufactured in whole or part from wood. They become faded and unsightly in appearance. Furthermore, the adhesives that are used are not suitable for the temperature that occur inside the dishwasher. Delicate decorative glassware and vases, special antique or irreplaceable china. The decorative patterns on such items will not be dishwasher-proof.

Plastic objects that are not resistant to hot water, copper and pewter utensils are also not suitable. Decorative patterns printed or painted onto the surface of crockery, glasses, etc., aluminium and silver items tend to become discoloured or faded if washed in the dishwasher. Some types of glass can become opaque in appearance after they have been washed many times in a dishwasher. Highly absorbent materials, such as sponges and towels, should never be placed in the dishwasher.

Our recommendation

In future, only purchase table or kitchenware that has been confirmed as being dishwasher-proof.



Important

Dishes or cutlery that have been soiled by tobacco ash, wax, lubricating grease or paint, should not be put in the dishwasher.

Damage to glassware and other dishes

Possible causes

- type of glass or manufacturing process
- chemical composition of detergent
- water temperature and duration of dishwasher programme.

Suggested remedy

- Use glassware or porcelain dishes that have been marked 'dishwasher-proof' by the manufacturer.
- Use a mild detergent that is described as 'kind to dishes'. If necessary, seek further information from detergent manufacturers.
- Select a programme with a low temperature and a short duration as possible.
- To prevent damage, take glass and cutlery out of the dishwasher as soon as possible after the programme has ended.

Arranging crockery, glasses, etc. in the dishwasher

en

Before placing the dishes in the dishwasher, remove larger food particles to prevent the filter from becoming clogged, which results in reduced performance.

If the pots and pans have baked-on food that is extremely hard to remove, we recommend that they are soaked before washed. This will eliminate the need for extra wash cycles.

Pull out the rack to load the dishwasher.

How to use the lower rack

We recommend that you place the most difficult to clean items on the bottom rack: pots, pans, lids, serving dishes and bowls, as shown in the figure to the right.

It is preferable to place serving dishes and lids on the sides of the racks in order to avoid blocking the rotation of the top spray arm.

- Pots, serving bowls, etc. must always be placed face down (see fig.D) .
- Deep pots should be slanted to allow the water to flow out.
- The lower rack features fold down tine rows (see fig.E) so that larger or more pots and pans can be loaded.



Warning

knives and other utensils with sharp points must be loaded in the basket with their points down or placed in a horizontal position.

Normal daily load

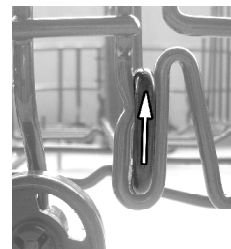
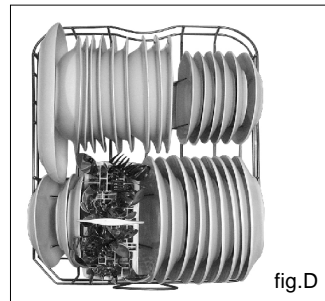

E1

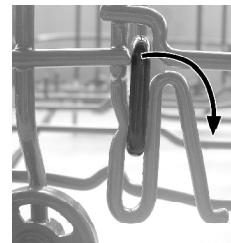

E2



E3

fig.E

How to use the upper rack

The upper rack is designed to hold more delicate and lighter dishware, such as glasses, cups and saucers, plates, small bowls and shallow pans (as long as they are not too dirty).

- Position the dishes and cookware so that they do not get moved by the spray of water.
- The upper rack can be adjusted for height by using the knobs located on the sides of the rack itself (see fig.F).

Adjust the upper basket to the higher level and you have more space to accommodate those taller pans and trays in the bottom basket.

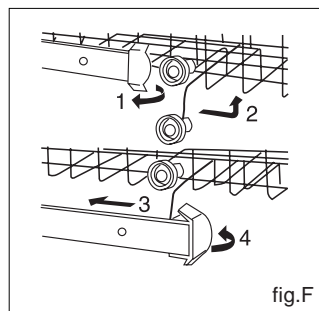

Shelf





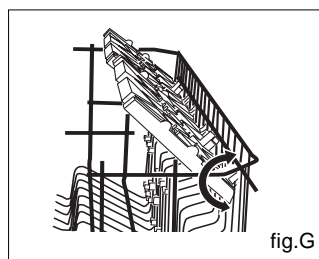

Lean tall glasses and those with long stems against the shelf - not against other items to be washed.

Place glasses, cups and small bowls on the additional cup rack. The additional cup rack can be swivelled in or out as required (see fig.G).



Programme overview

en

Wash programme	Type of crockery e.g. china, pots/pans, cutlery, glasses, etc	Type of food remains	Amount of food remains	Condition of food remains	Description of cycle	1/2 Load	3 in 1
 Intensive Wash	Non-delicate	Soups, casseroles, sauces, potatoes, pasts, rice, eggs, roast or fried food.	a lot	stuck on hard	Pre-wash with hot water. Extended wash at 70°C. Rinses with cold water. Rinse with hot water. Drying.	—	●
					Pre-wash use cold water. Extended wash at 55°C. Rinse with cold water. Rinse with hot water. Drying.	●	●
 Normal Wash						—	●
						●	●
 Light Wash (EN50242)		Soups, potatoes, pasta, rice, eggs, roast or fried food.	a little	loosely attached	Pre-wash use cold water. Extended wash at 50°C. Rinse with cold water. Rinse with hot water. Drying.	—	●
						●	●
 Glass ware	Mixed	Coffee, cakes, milk, sausage, cold drinks, salads	Very little	loosely attached	Wash at 45°C. Rinse with cold water. Hot rinse. Drying.	—	●
					●	●	
 Rapid wash					Short wash at 40°C. Cold rinse.	—	—
						●	—
 Heat wash		For dishes that need to be rinsed and dried only.			Hot rinse at 65°C. Drying.	—	—
						●	—
 Soak		Rinse off if the dishes have been stacked for several days in the dishwasher prior to washing.			Short cold wash to prevent food residue from drying on the dishes.	—	—
						●	—

Delayed Start	Detergent		Rinse Aid
	Extended Wash	Prewash	
●	25g	5g	●
●	25g	5g	●
●	25g	5g	●
●	25g	5g	●
●	25g	5g	●
●	25g	5g	●
●	25g	5g	●
●	15g	—	●
●	10g	—	●
●	15g	—	—
●	10g	—	—
●	—	—	●
●	—	—	●
●	—	—	—
●	—	—	—

Laboratory measured valve in accordance with European Standard EN50242

Duration in minutes	Energy consumption in kWh	Water consumption in litres
112	1.44	18
94	1.25	16
102	1.11	15
90	1.00	14
162	0.80	15
140	0.76	13
92	1.01	12
82	0.95	10
32	0.40	9
28	0.30	8
54	0.90	5.5
48	0.78	5
12	0.02	3
12	0.02	3

Programme selection

The most appropriate programme can be identified by comparing the type of crockery, cutlery, etc., as well as the amount and condition of food remains, with the details contained in the wash cycle table. The corresponding programme sequence, duration and consumption details are shown in the right half of the overview.

For example:

Use the « normal»  programme for dishes and utensils which have plenty of food remains stuck on hard.

Earn savings

If only a small number of dishes have been loaded into the dishwasher, selecting a programme that operates at the next lowest temperature will usually be sufficient.

Programme data

The stated programme data are based on standard operating conditions. The values can vary considerably according to:

- different amounts of dishes
- temperature of mains water supply
- pressure of mains water supply
- ambient temperature
- fluctuations in mains voltage
- machine-related factors (e.g. temperature, water volume,...)

Switching the dishwasher ON

- Turn on the tap.
- Open the door.
- Set ON-OFF button “I” to ON.
- Press programme button “B”, programme indicator “A” lights and the time-remaining indicator “F” displays the time of the programme..
- Close the door, the programme indicator “A” becomes to light and the programme starts automatically.

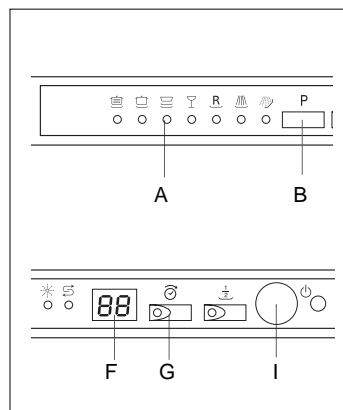

End of programme

- Six beeps will indicate that the wash cycle has finished.

Switching the dishwasher OFF

Several minutes after the programme has ended:

- Open the door.
- Set ON-OFF button “I” to OFF.
- Remove dishes, etc. when they have cooled down.

Interrupting the programme

- A cycle that is underway can be modified if it has only been running for a short time. Otherwise, the detergent may have already been used, and the appliance may have already drained the wash water. If this is the case, the detergent dispenser must be refilled (see the paragraph entitled, “ Loading the detergent ”).
- Open the door. Caution! There is a risk of water squirting out from inside the appliance. Do not open the door fully until spray arm has stopped rotating.
- When you open the door, the dishwasher will beep ten times every thirty seconds.
- If the appliance has already heated up or the hot water was switched ON and then the appliance door opened, leave the door ajar for several minutes and then close. Otherwise, the appliance door may open due to expansion.

Delayed start programming

You can delay the start of a programme in increments of 1 hour up to 24 hours.

- Switch dishwasher **ON**.
- Press programme button "**B**" to choose the desired programme.
- Immediately press the Delayed Start button "**G**", the delayed start indicator lights, the delayed start time indicator "**F**" changes to "00".
- Press the Delayed Start button "**G**" as many times as necessary until the numerical display shows the required delay.
- To cancel the time delay setting, pressing the Delayed Start button until the delayed start indicator goes out.
- Close the door, the delayed start indicator "**G**" blinks, the time-remaining indicator "**F**" will blink and decrease, the programme will start until the delayed start indicator "**G**" goes out.

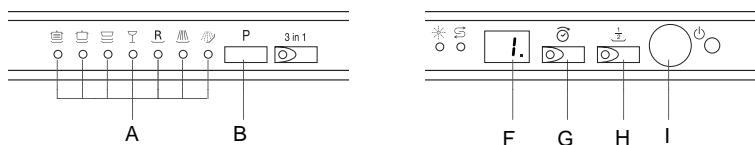

1/2 Load Button

This button "H" (see "Close-up View (Control Panel) ") makes it possible to wash dishes using only the upper rack if there are not enough dishes for a full load. This will allow you to save on water and energy consumption.

To select 1/2 load:

- Select the programme (see the paragraph entitled " Switching the dishwasher ON")
- Press the 1/2 load button "**H**", 1/2 load indicator lights.
- Close the door, the programme starts automatically.

To cancel the 1/2 load while underway

- Press programme button "**B**" and hold it in for about 3 seconds.

- Please keep in mind that the amount of detergent should also be adapted to the 1/2 load.

3in1 function

When using "3 in 1" combination products, the rinse-aid and salt lights are no longer useful. It may be helpful therefore to switch the rinse aid off (please note that only some dishwashers have this facility) and selecting the lowest possible setting for water hardness.

If you decide to switch to the use of a standard detergent system we advise that you:

- 1: Refill both the salt and rinse aid compartments.
- 2: Switch the waterhardness setting to the highest possible position and run for three normal cycles without a load.
- 3: Readjust the waterhardness setting again according to the conditions for your region (For more information please refer to your instruction manual).



Notice:

Do not place the tablets in the tub or the cutlery basket as this will result in poorer wash results. The tablets should be placed in the detergent doser.



Memory Function Module

If the dishwasher is switched off through the ON/OFF button, or a current leak happens while the selected washing program is active, the program is not cancelled. The controls use a microprocessor device, to memorize the information about the selected washing program. Once the machine is again powered on, the dishwasher will be resumed from the point it was interrupted.

Canceling or modifying a washing program cycle

- 1: To modify or cancel the carrying out of a washing cycle (being the door opened), it's necessary to reset the previous programming, by holding pushed the programme selector button "B" for at least 3 seconds, and the buzzer emits one short warning signal.
- 2: If the reset operation was successful, a drain phase is started. Once the drain phase is ended, the dishwasher stands waiting for a new programming
- 3: A cycle that is underway can be modified if it has only been running for a short time. Otherwise, the detergent may have already been used, and the appliance may have already drained the wash water. If this is the case, the detergent dispenser must be refilled.

Tabs

With Classic Tabs you can put your dirtiest dishes straight into the dishwasher. The tab contains StainSoakers which dissolve instantly to soften really dried on food residues such as baked on egg and cheese sauces. The blue layer then works to break down and lift off food remains while the white layer cleans all traces of dirt away for a spotless and brilliant finish.

For best results use with Rinse Aid and Special Salt.

Directions: Simply unwrap one tab and place in the detergent dispenser of your dishwasher. For best results, use with Rinse Aid and Special Salt.

3in1 Tabs

With powerful grease cutting action, 3in1 Tabs effectively remove tough stains, so you don't have to re-wash!

The blue layer contains powerful detergent and Red StainSoaker speckles to soften and break down tough dried-on stains.

The white layer, with its integrated salt function, softens the water and prevents limescale whilst removing all traces of residue.

The 3in1 tab contains a rinse aid ball to deliver a spotless, streak free brilliant shine.

3in1 tabs are pre-measured so there's never any guessing, measuring, mess or waste.

Directions: Simply unwrap one tab and place in the detergent dispenser of your dishwasher. No need to add additional salt or rinse aid. 3in1 Tabs' salt-action is effective in soft, medium and hard water up to 26° „e (around 95% of households).

5in1 Tabs

Are you looking for unbeatable cleaning performance from your dishwashing detergent? 5in1 Tabs have taken dishwashing to the next level with an extra cleaning power to remove encrusted stains for an extreme clean.

1. The tablet is formulated with powerful detergent and red StainSoaker speckles to help penetrate and break down the toughest baked-on and dried-on stains, even tea stains.
2. Using a rinse aid function, the tab is developed for a spotless, streak-free sparkling shine.
3. In the white layer of the tablet, the 5in1 Salt-action prevents limescale deposits in your machine that can result in residue on your glasses.
4. Protector Action helps prevent permanent glass corrosion, a source of cloudy glasses.
5. The tab gives extra cleaning power to help remove encrusted stains for a complete clean.

Directions: Simply unwrap one tab and place in the detergent dispenser of your dishwasher. 5in1 Salt-Action is effective in soft, medium and hard water up to 26° „ e (approximately 95% of households).

After Every Wash

After every wash, set the main switch "I" to off and leave the door slightly ajar so that moisture and odors are not trapped inside.

Remove the plug

Before cleaning or performing maintenance, always remove the plug from the socket. Do not run risks.

No solvents or Abrasive Cleaning Products

To clean the exterior and rubber parts of the dishwasher, do not use solvents or abrasive cleaning products. Rather, use only a cloth and warm soapy water.

To remove spots or stains from the surface of the interior, use a cloth dampened with water and a little white vinegar, or cleaning product made specifically for dishwashers.

Moving the Appliance

If the appliance must be moved, try to keep it in a vertical position. If absolutely necessary, it can be positioned on its back.

Seals

One of the factors that cause odors to form in the dishwasher is food that remains trapped in the seals. Periodic cleaning with a damp sponge will prevent this from occurring.

The door should not be left in the open position since this could present a tripping hazard.

When You Go on Holiday

When you go on holiday, it is recommended that you run a wash cycle with the dishwasher empty and then remove the plug from the socket, turn off the water supply and leave the door of the appliance slightly ajar. This will help the seals last longer and prevent odors from forming within the appliance.

Regular inspection and maintenance of your appliance helps to prevent problems from occurring. This saves time and aggravation. You should therefore carefully inspect the inside of your dishwasher from time to time.

Overall condition of appliance

- Check that no grease or scale has accumulated on the inside of the dishwasher.

If you discover any deposits:

- Clean the interior of the dishwasher thoroughly with a detergent solution.

Dishwasher salt

Check the LOW SALT indicator “E”. Top up with salt, if required.

Rinse-aid

Check the LOW RINSE AID indicator “D”, on the front panel.

Top up with rinse-aid, if required.

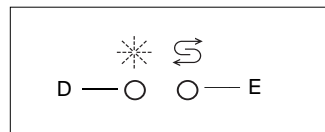

Filters

The filters “7”, “8” prevent larger particles of food in the water from reaching the pump. These particles may occasionally block the filters.

- When the appliance has finished washing, check the filters for particles of food and, if required, clean.
- After undoing the coarse micro-filter “7”, the filter unit “9” can be removed. Remove any particles of food and rinse the filters under running water.
- Insert the filter unit “8” and tighten the coarse micro-filter.

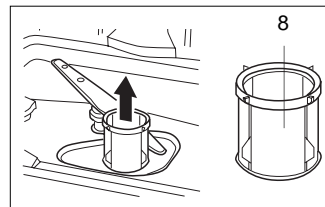
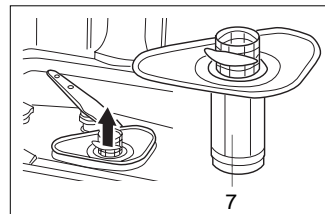

Spray arms

Lime and remnants of food in the washing water can block the nozzles in the spray arms “9” and “10” and the arm mountings.

- Inspect the nozzles in the spray arms for blocked holes due to remnants of food.
- If necessary, pull the lower arm “10” upwards and lift it off.
- Unscrew the upper spray arm “9”.
- Clean both spray arms under running water.
- Refit the spray arms. Ensure that the lower arm has locked into place and the upper one is screwed tight.

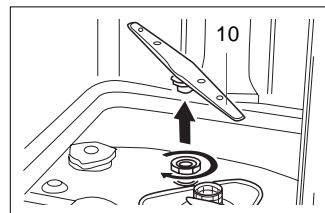
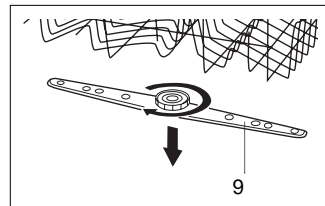

Resolving minor problems yourself

Experience has shown that you can resolve most problems that arise during normal daily usage yourself, without having to call out a service engineer. Not only does this save costs, but it also means that the appliance is available for use again that much sooner. The following list of common occurrences and their remedies should help you identify the causes of most problems.

Problems...

...when the appliance is switched on

Appliance does not start up

- Fault with fuse in mains electricity supply.
- Plug not inserted in wall socket.
- Appliance door not closed properly.
- Programme button has not been pressed.
- Water tap not turned on.
- Blocked strainer in water intake hose.
 - The strainer is situated in the Aquastop or supply-hose connection.



Caution

Do not forget that repairs should only be carried out by a qualified specialist. Improper repairs can lead to considerable equipment damage as well as danger to the user.

...with the appliance itself

Error display on the time-remaining indicator

When “E 1” (F) blinks.

Have you checked whether:

- the door is closed properly.

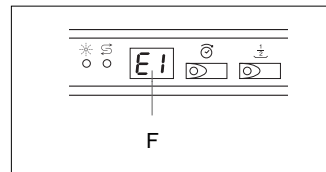

When “E 3” (F) blinks.

Have you checked whether:

- the drain hose is too low.

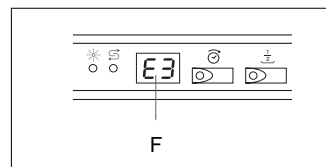

When “ F4 ” (F) blinks.**Have you checked whether:**

- the drain hose is crimped or bent.
- the drain hose is too high.

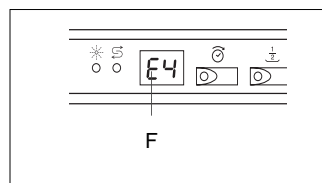
**When “ E5 ” (F) blinks.****Have you checked whether:**

- the water is turned on and the hose is connected properly;
- the water supply to the house is on and has sufficient pressure;
- the water supply hose is crimped or bent;
- the filter for the water supply hose is clogged.
- the drain hose is too low.

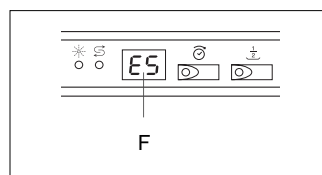

If you take all these checks and the dishwasher still does not function or your dishwasher have any other error display, you can power the dishwasher OFF, and wait a few minutes. You can power the dishwasher on, try it again , if the dishwasher still does not function and/or the problem persists, contact the nearest authorised service center and provide them with the following information:

- the nature of the problem.
- the model type number (Mod...) And the serial number (S/N...), which are indicated on the plate located on the side of the inner part of the door.

Lower spray arm rotates with difficulty

- Spray arm is blocked by small items or food remains.

Lid in detergent compartment cannot be closed

- Detergent compartment has been overfilled.
- Mechanism is clogged with remnants of detergent.

Indicator lamps do not extinguish after washing has finished

- Main switch is still set to ON.

Remnants of detergent stuck inside dispenser

- Compartment was damp when it was filled up with detergent. Compartment must be dry before detergent is added.

Water remains inside appliance after programme has ended

- Blockage or kind in drainage hose.
- Pump is jammed.
- Filters are blocked.
- The programme is still running. Wait for the programme to end .

...during washing**Unusual amount of foam is creased**

- Normal washing up liquid has been poured into the rinse-aid container.
- Remove any spilled rinse aid with a cloth as it could otherwise lead to excessive foaming during the next washing cycle.

Appliance stops suddenly while washing is taking place

- Cut off electricity supply to appliance.
- Water supply has been interrupted.

Knocking sound can be heard while washing is taking place

- A spray arm is knocking against the dishes inside the appliance.

Rattling sound can be heard while washing is taking place

- Crockery has not been stacked properly inside the appliance.

Knocking sound coming from inlet valves

- This is caused by the way the water pipes have been laid and it has no effect upon the way the appliance functions. There is no remedy for this.

...with the dishes, cutlery, etc.**Remnants of food are stuck to the dishes, cutlery, etc.**

- Dishwasher was not loaded properly. Jets of water could not reach all parts of the dishes, etc.
- Too many items in the rack.
- Items in the rack were touching each other.
- Not enough detergent was added to dispenser.
- Selected wash programme was not intensive enough.
- Rotation of spray arm was obstructed by dishes, etc.
- Nozzles in spray arm are blocked by remnants of food.
- Filters are blocked.
- Filters have been incorrectly fitted.
- Waste-water pump is jammed.

Plastic items are discoloured

- Not enough detergent was added to dispenser.
- Detergent has insufficient bleaching properties. Use a detergent containing a chemical bleaching agent.

White stains are left on crockery, glasses have a milky appearance

- Not enough detergent was added to dispenser compartment.
- Amount of rinse-aid was set too low.
- Although water is quite hard, no salt has been put in appliance.
- Water softener was set too low.
- Lid on salt container is not screwed tight.
- If you used a phosphate-free detergent, try a detergent containing phosphates and compare results.

Dishes, cutlery, etc. have not been dried

- Selected programme did not include drying function.
- Amount of rinse-aid was set too low.
- Items were removed from dishwasher too soon.

Glasses have a dull appearance

- Amount of rinse-aid was set too low.

Tea stains or traces of lipstick have not been completely removed

- Detergent does not have a sufficient bleaching effect.
- Washing temperature was set too low.

Traces of rust on cutlery

- Cutlery is not sufficiently rustproof.
- Salt content in washing water is too high.
 - Lid on salt container is not screwed tight.
 - Too much salt was spilt while filling container.

Glasses become clouded and discoloured; coating cannot be wiped off

- Unsuitable detergent was used.
- Glasses are not dishwasher-proof.

Smears left behind on glasses and cutlery; glasses have acquired a metallic appearance

- Amount of rinse-aid set too high.

Technical data

en

Width	44.6cm
Depth	55 cm
Height	82 cm
Capacity	9 standard place settings
Mains water pressure	0.03-0.6MPa
Power voltage	220-230V~ 50Hz
Maximum current intensity	13A
Total absorbed power	2150W

Important information

Notes on waste disposal

Old appliances still have some residual value. An environment-friendly method of disposal will ensure that valuable raw materials can be recovered and used again.

When an appliance has reached the end of its working life, unplug it from the mains. Cut through the mains cable and dispose of it together with the plug.

Destroy the door locking mechanism. This will ensure that children at play cannot become locked inside and are not exposed to the risk of suffocation.

Your new appliance was protected by suitable packaging while it was on its way to you. All materials used for this purpose are environment-friendly and can be recycled. Please make a contribution to protecting the environment by disposing of the packaging appropriately.

Do not allow children to play with any parts of the packaging. There is a risk of suffocation by the cardboard boxes and the plastic wrapping.

Up-to-date information concerning options for disposal can be obtained from your retailer or local municipal administration.

General information

Measures must be taken to ensure that built-under and built-in units that are subsequently re-sited as free-standing appliances cannot topple over. This can be achieved by bolting the dishwasher to the wall or fitting it under a continuous work surface which is screwed to the adjacent cupboards.

Information on comparability tests implemented in compliance with EN 50242

Appliance loaded in accordance with standard specifications.

Example of loaded dishwasher: See Fig 1 and 2.

Capacity: 9 place settings

Comparability programme: Light wash

Rinse-aid setting: 5

Detergent: 25g+5g

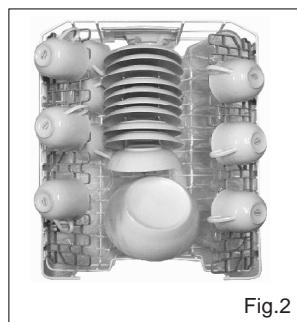
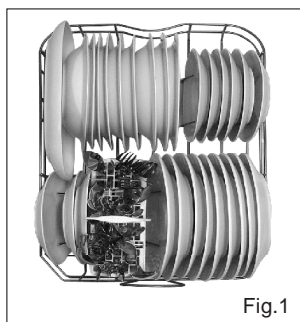

Height-adjustable top-basket must be inserted in the uppermost position.

If the comparability tests do not comply fully with EN 50242, e.g., degree of soiling, type of dishes and cutlery, etc., contact the appliance manufacturer before starting the test.

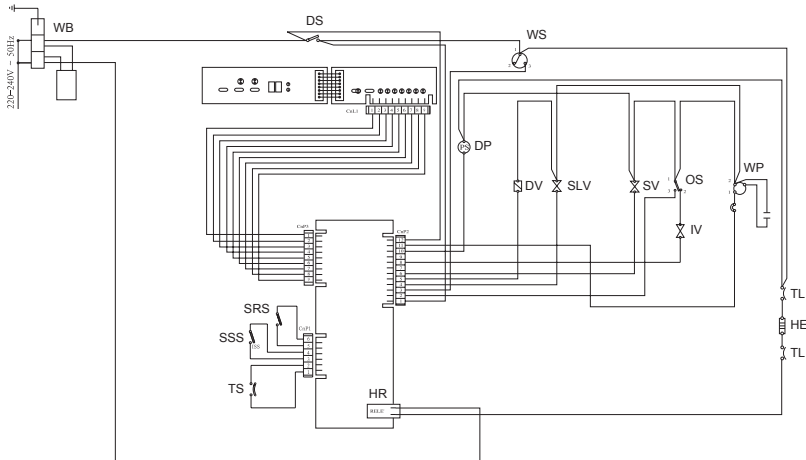

WB: Wiring box	SV: Softener valve	HR: Heating element relay
DS: Door switch	OS: Overflow switch	SSS: Spy salt switch
WS: Water level switch	IV: Inlet valve	SRS: Spy rinse aid switch
DP: Drain pump	WP: Washing pump	TS: Temperature sensor
DV: Dispenser valve	TL: Temperature limiter	
SLV: Single layer valve	HE: Heating element	



The symbol  on the product or on its packaging indicates that this product may not be treated as household waste. Instead it shall be handed over to the applicable collection point for the recycling of electrical and electronic equipment. By ensuring this product is disposed of correctly, you will help prevent potential negative consequences for the environment and human health, which could otherwise be caused by inappropriate waste handling of this product.

For more detailed information about recycling of this product, please contact your local city office, your household waste disposal service or the shop where you purchased the product.

